



LUMINAIRES SOLAIRES/2026
SOLAR LIGHTING/2026

LES JARDINS[®]
AIX-EN-PROVENCE

OUTDOOR FURNITURE & SOLAR LIGHTING DESIGNER



Plein Soleil : Nouvelle Saison, Nouvelles Collections.
Découvrez comment la technologie solaire peut transformer votre extérieur. Avec toujours plus d'innovation et de design, plongez dans le monde de l'éclairage solaire et donnez une nouvelle vie à vos espaces extérieurs. Adopter l'éclairage solaire n'a jamais été aussi créatif et innovant. Bienvenue dans notre nouveau catalogue, où chaque page est une invitation à adopter la puissance et l'élégance de l'éclairage solaire.

Full Sun: New Season, New Collections.
Discover how solar technology can transform your outdoor space. With ever-increasing innovation and design, dive into the world of solar lighting and breathe new life into your exterior areas. Embracing solar lighting has never been so creative and innovative. Welcome to our new catalog, where each page invites you to harness the power and elegance of solar lighting.

Georges BONICHON
CEO

LES JARDINS®
AIX-EN-PROVENCE

VISION SOLAIRE

Entretien avec Geoffrey Marcel / Ingénieur LES JARDINS®

Pouvez-vous nous parler de l'origine de LES JARDINS® et de la vision de votre père ?

Geoffrey Marcel : Bien sûr. LES JARDINS® a été fondée en 1990 par mon père, Denis Marcel. L'éclairage solaire LES JARDINS® est né en 2015 de sa volonté d'élargir notre offre pour les aménagements extérieurs, tout en préservant nos maîtres mots qualité, durabilité et raffinement. Partant d'un cahier des charges ambitieux pour un marché à forte croissance, nous souhaitons développer un éclairage d'extérieur à la fois performant et esthétique, facile à installer et à maintenir, non sujet aux aléas que peuvent subir les câbles électriques en extérieur. J'interviens sur cette gamme depuis fin 2016, d'abord au travers de mon bureau d'étude en électronique et désormais en tant que membre à part entière de l'équipe Les Jardins, pour que cette vision soit réalité au travers de notre gamme en pleine extension.

Comment LES JARDINS® a-t-elle su combiner son savoir-faire en mobilier et en électronique ?

G.M. : Depuis 1990, LES JARDINS® a développé une solide expertise dans le domaine du mobilier. Nous avons ensuite intégré des compétences électroniques en interne, ici en France. Cette combinaison nous permet de proposer une gamme de produits qui marie matériaux nobles, designs avant-gardistes et performances d'éclairage exceptionnelles. Notre objectif est de fournir des produits autonomes, simples à utiliser, avec un mode intelligent accessible d'un seul clic pour répondre à la majorité des besoins, tout en offrant des options de personnalisation avancées.

Vous mentionnez la fiabilité et la durabilité. Pouvez-vous nous en dire plus ?

G.M. : Absolument. Nous nous engageons à réduire notre impact environnemental en concevant des produits fiables et robustes, conçus pour résister aux conditions extérieures les plus extrêmes. En 2023, nous avons amélioré notre certification d'étanchéité, passant de IP55 à IP66. Nos produits avec port de recharge USB-C permettent de réutiliser les chargeurs et câbles existants. Grâce à nos bancs de test et de cyclage de batteries, nous assurons une gestion optimale des batteries, souvent au-delà de la durée de vie spécifiée par nos fournisseurs.

Offrez-vous un service après-vente pour vos produits ?

G.M. : Oui, nous assurons un service de réparation pour nos produits. En France, je m'occupe personnellement des retours de modules solaires. Après contrôle et réparation si nécessaire, plus de 80 % des modules sont remis en service. Les modules sont conçus pour être facilement démontables, facilitant ainsi les interventions sur les composants électroniques. Cette approche nous permet d'améliorer continuellement nos produits, visant le zéro défaut.

Vous avez récemment lancé une ligne de production en France. Pouvez-vous nous en parler ?

G.M. : En 2023, nous avons intégré un ingénieur 3D pour lancer une ligne de produits fabriqués en France, utilisant les techniques de fabrication additive les plus récentes. L'impression 3D nous permet de créer des lampes aux formes et effets lumineux innovants, impossibles à obtenir par les méthodes traditionnelles. La gamme Lolie en est un excellent exemple. Nous continuons d'élargir notre

parc machines pour rester compétitifs, produire à la demande et offrir une large gamme de personnalisations, tout en adoptant une logistique en circuit court. Nous poursuivons notre démarche d'amélioration continue pour garantir des produits toujours plus durables et robustes.

Un dernier mot sur l'avenir de LES JARDINS® ?

G.M. : Nous restons fidèles à notre vision initiale tout en innovant constamment. Notre objectif est de continuer

à offrir des solutions d'éclairage extérieur qui allient performance, durabilité et esthétique, tout en étant à l'écoute de nos clients pour répondre à leurs besoins en constante évolution.

SOLAR VISION

Interview with Geoffrey Marcel / Engineer at LES JARDINS®

Can you tell us about the origin of LES JARDINS® and your father's vision?

Geoffrey Marcel : Of course LES JARDINS® was founded in 1990 by my father, Denis Marcel. LES JARDINS® solar lighting was born in 2015 from his desire to broaden our offering for outdoor landscaping, while preserving our watchwords of quality, durability and refinement. Based on ambitious specifications for a fast-growing market, we wanted to develop outdoor lighting that was both high-performance and aesthetically pleasing, easy to install and maintain, and not subject to the hazards that outdoor electrical cables can suffer. I've been working on this range since late 2016, first through my electronics design office and now as a full member of the Les Jardins team, to make this vision a reality through our expanding range.

How has LES JARDINS® managed to combine its expertise in furniture and electronics?

G.M. : Since 1990, LES JARDINS® has developed solid expertise in the field of furniture. We then integrated in-house electronics expertise, here in France. This combination allows us to offer a range of products that blend noble materials, avant-garde designs, and exceptional lighting performance. Our goal is to provide autonomous products that are easy to use, with a smart mode accessible with a single click to meet most needs, while offering advanced customization options.

You mention reliability and durability. Can you tell us more about that?

G.M. : Absolutely. We are committed to reducing our environmental impact by designing reliable and robust products, made to withstand the most extreme outdoor conditions. In 2023, we improved our waterproof certification from IP55 to IP66. Our products with USB-C charging ports allow for the reuse of existing chargers and cables. Thanks to our battery testing and cycling benches, we ensure optimal battery management, often beyond the lifespan specified by our suppliers.

Do you offer after-sales service for your products ?

G.M. : Yes, we provide a repair service for our products. In France, I personally process the returned solar modules. After inspection and repair if necessary, more than 80% of the modules are put back into service. The modules are designed to be easily disassembled, simplifying interventions on the electronic components. This approach allows us to continuously improve our products, perserving zero defects.

You recently launched a production line in France. Can you tell us about it?

G.M. : In 2023, we hired a 3D engineer to launch a line of products made in France, using the latest additive manufacturing techniques. 3D printing allows us to create lamps with innovative shapes and lighting effects that are impossible to achieve with traditional methods. The Lolie range is

a great example of this. We continue to expand our machine fleet to remain competitive, produce on demand, and offer a wide range of customizations while adopting logistics chains. We are pursuing our continuous improvement approach to ensure ever more durable and robust products.

Our goal is to keep offering outdoor lighting solutions that combine performance, durability, and aesthetics.

A final word on the future of LES

JARDINS®?

G.M. : We remain true to our original vision while constantly innovating. Our goal is to continue offering outdoor lighting solutions that combine performance, durability, and aesthetics, while listening to our customers to meet their ever-evolving needs.

Collections 2025 / 2026



Cadix p/16



Halo p/20



Teckalu p/22



Pastek p/60



Rop&Strip p/62



Tradition p/70



Teckinox p/34



Tecka p/36



Verti p/44



Bateak & Tyble p/78



Rancho p/80



Bump p/81



Alba p/45



Skaal p/46



Tekura p/54



Made in France p/82



Jet Stream p/94



Mandaley p/98

Collections 2025 / 2026



Osmoz p/100



Selva p/102



Corner p/103



Tinka p/104



Blade p/110



Tulip p/112



Metro p/114



Oje p/118



Envergure p/122

Bonnes pratiques Best practices p 124

Norme PMR PMR standard p 125

Matériaux Materials p 126

Entretien Cleaning products p 127

Explorez nos collections
& inspirez-vous !

Application LES JARDINS®3D
à télécharger sur mobile



Septembre 2025. Ce document n'est pas contractuel. La société SEL se réserve le droit de modifier ou de supprimer de plein droit certaines informations de ce catalogue. Non-contractual document. The SEL company reserves the right to eliminate or change information in the catalogue by right.
Photos : Arnaud Childeric (Kalice Photographes) - Alexi Marizy - Dominique Plachta (Galerie Vision). Ce catalogue a été réalisé grâce à l'aide de Christelle, Frédéric et Philippe. Merci à toute l'équipe.

SEL - 1115 rue René Descartes - ZAC du Parc de la Duranne - 13100 Aix-en-Provence - France
Tél. (33) 04 42 90 45 30 - Fax (33) 04 42 90 70 11 - Email : contact@lesjardins.com - www.lesjardins.com
RC AIX 2002 B 1217 - Siret 354 044 257 00054 - APE 516 K - TVA FR 49354044257
SAS au capital social de 451 290 Euros.



FR
Donnez ou recyclez
vos meubles.



Association



Magasin



Déchèterie

<https://quefairedemesdechets.fr>

Selon vos besoins

Lampe de table

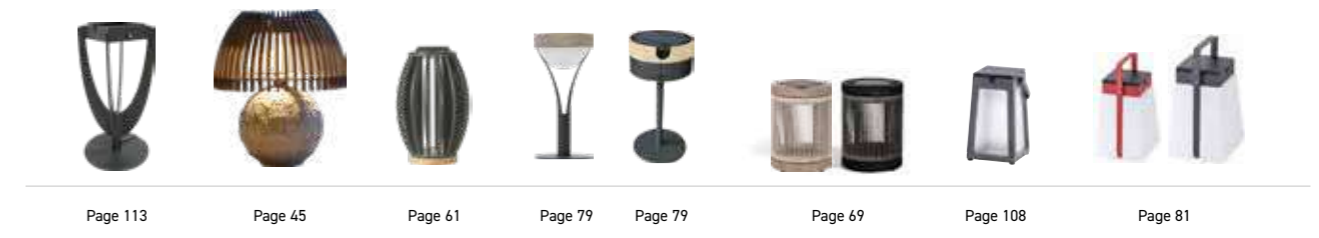

Lanterne



Borne



Table basse lumineuse



Selon vos besoins

Torche



Lampadaire



Applique et suspension



Lampadaire XL





LE SOLAIRE

HAUTE PERFORMANCE ET INTELLIGENT

HIGH-PERFORMANCE, SMART SOLAR

Plus qu'un simple composant, nos modules solaires sont une création originale **LES JARDINS®**, pensée, conçue et pilotée par notre équipe en France. Cette maîtrise du design et de la technologie nous permet de proposer une solution unique, performante et durable. Véritable solaire intelligent, nos modules hautes performances s'adaptent naturellement aux jours et aux saisons pour délivrer le meilleur de l'éclairage solaire. Évolutifs et réparables, ils sont conçus avec les composants les plus performants pour garantir un rendement optimal. Simples, automatiques et autonomes, ils reflètent notre savoir-faire et notre engagement pour un solaire durable. Et parce que nous croyons à la qualité et à la proximité, un **service après-vente dédié dans nos locaux à Aix-en-Provence** accompagne nos clients pour assurer le suivi et la longévité de nos produits.

More than just a component, our solar modules are an original **LES JARDINS®** creation, imagined, designed, and driven by our team in France. This mastery of design and technology allows us to deliver a solution that is unique, high-performing, and built to last. As true smart solar, our high-performance modules naturally adapt to days and seasons to provide the very best in solar lighting. Evolving and repairable, they are built with the most advanced components to ensure optimal efficiency. Simple, automatic, and fully autonomous, they embody our expertise and our commitment to sustainable solar solutions. And because we believe in quality and proximity, a **dedicated after-sales service located in our facilities in Aix-en-Provence** supports our customers to ensure product care and long-term reliability.

Modèle	Luminosité max.	Température de couleur	Autonomie	Recharge	Modes	Dimensions / Particularités	Détecteur de présence	Usage recommandé
 MODULE SOLAIRE INTELLIGENT SMART MODULE SOLAR MRS200 79 €	200 lm	2700K (blanc chaud)	8h (200 lm) 16h (100 lm) 31h (50 lm)	9h solaire 5h USB-C	2 modes (intelligent / marche forcée)	Compact, 3 LEDs, port USB-C étanche IP66	Non	Lampe de table, lampe à poser, lampion, petite torche
 MODULE SOLAIRE INTELLIGENT SMART MODULE SOLAR TINK70i 79 €	300 lm	3000K (blanc doux)	4h (300 lm) 8h30 (150 lm) 17h (75 lm)	8h solaire 4h USB-C	2 modes (intelligent / marche forcée)	Standard, 5 LEDs, port USB-C étanche IP66	Non	Lampe de table, lampe à poser, lampion, petite torche
 MODULE SOLAIRE INTELLIGENT SMART MODULE SOLAR TINK72i 119 €	500 lm	2700K (blanc chaud)	5h (500 lm) 10h30 (250 lm) 21h (125 lm)	8h solaire 7h USB-C	3 modes (intelligent / personnalisé / marche forcée)	Standard, 10 LEDs, port USB-C étanche IP66	Oui (activable/désactivable, éclaire 30s à 500 lm)	Lanterne, applique, balisage, lampadaire, lampe à poser

new//

i-500 lumens MAX // Fiabilité et performance en toutes saisons

Conçu pour les environnements exigeants, le C500 Max est le module solaire professionnel par excellence. Avec son panneau solaire extra-large de 4,5 W, il assure une recharge rapide même en exposition difficile (x2 plus rapide).

MODULE SOLAIRE INTELLIGENT
SMART MODULE SOLAR

 TINK73i 139 €	500 lm	2700K (blanc chaud)	5h (500 lm) 10h30 (250 lm) 21h (125 lm)	4h solaire 7h USB-C	3 modes (intelligent / personnalisé / marche forcée)	10 LEDs, port USB-C étanche IP66 Grand panneau (18×18 cm), recharge rapide x2	Oui (activable/désactivable, éclaire 30s à 500 lm)	Balisage, applique, lampadaire, lampe à poser
---	---------------	---------------------	---	------------------------	---	---	---	---



i-500 lumens MAX // Reliability and performance in all seasons

Designed for demanding environments, the C500 Max is the ultimate professional solar module. With its extra-large 4.5 W solar panel, it ensures fast charging even in difficult conditions (twice as fast).

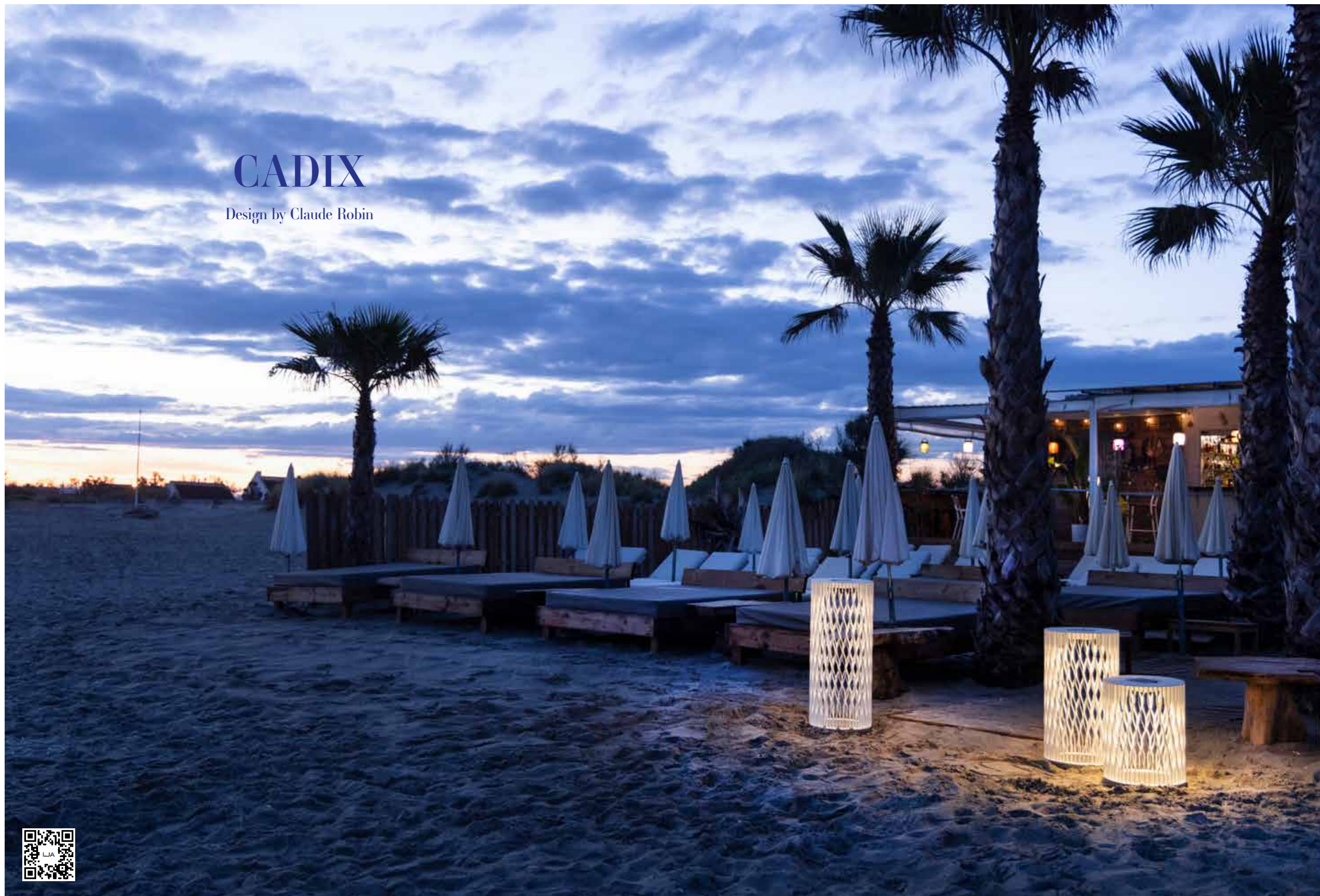

CADIX

Design by Claude Robin







LAMPE CADIX
50 CM
CADIX LAMP H 19.6"

-  **769 €**
TINK650
Blanc, White
-  **769 €**
TINK656*
Noir, Black
-  **769 €**
TINK653*
Couleur Corten, Corten color

Aluminium, base en granite
Aluminum, granit base

 1 pc/2boxes  0,121 m³
 12,95 kg 

LAMPE CADIX
70 CM
CADIX LAMP H 27.5"

-  **869 €**
TINK651
Blanc, White
-  **869 €**
TINK657*
Noir, Black
-  **869 €**
TINK654*
Couleur Corten, Corten color

Aluminium, base en granite
Aluminum, granit base

 1 pc/2boxes  0,155 m³
 15,15 kg 

LAMPE CADIX
90 CM
CADIX LAMP H 35.4"

-  **998 €**
TINK652
Blanc, White
-  **998 €**
TINK658*
Noir, Black
-  **998 €**
TINK655*
Couleur Corten, Corten color

Aluminium, base en granite
Aluminum, granit base

 1 pc/2boxes  0,190 m³
 17 kg 

* Ces produits sont disponibles sur commande. These products are available to order.



LAMPE DE TABLE HALO
HALO TABLE LIGHT

 259 €
TINK700
Gris espace, Space grey

 259 €
TINK701
Blanc, White

Aluminium, granite
Aluminum, granit





 1pc/1box  0,013 m³
 2,15 kg 



TABLE BASSE LUMINEUSE HALO
HALO ILLUMINATED LOW TABLE

 649 €
dont éco-part. 0,66 €
TA04540

Aluminium gris espace,
HPL ceramique grise,
plaque en verre dépoli acrylique
Space grey aluminum, HPL grey
ceramic top, acrylic frosted glass plate

 649 €
dont éco-part. 0,66 €
TA04542

Aluminium couleur Corten,
HPL ceramique lin,
plaque en verre dépoli acrylique
Corten color aluminum, HPL linen
ceramic top, acrylic frosted glass plate

 1pc/1box  0,135 m³
 5,60 kg 



TABLE BASSE LUMINEUSE HALO
HALO ILLUMINATED LOW TABLE

 889 €
dont éco-part. 0,66 €
TA04541

Aluminium gris espace,
HPL ceramique grise,
plaque en verre dépoli acrylique
Space grey aluminum, HPL grey
ceramic top, acrylic frosted glass plate

 889 €
dont éco-part. 0,66 €
TA04543

Aluminium couleur Corten,
HPL ceramique lin,
plaque en verre dépoli acrylique
Corten color aluminum, HPL linen
ceramic top, acrylic frosted glass plate

 1pc/1box  0,350 m³
 9,85 kg 

TECKALU

Design by Claude Robin







TECKALU

LANTERNES À POSER SOLAIRES ET RECHARGEABLES ☀️
SOLAR AND RECHARGEABLE LANTERNS



LANterne TECKALU
36 CM
TECKALU GARDEN LANTERN H 14"

369 €
TECKA95

Aluminium blanc,
Teck massif à la finition Duratek®,
White aluminum,
Duratek® finish solid teak

1pc/1box 0,034 m³
3,5 kg

LANterne TECKALU
45 CM
TECKALU GARDEN LANTERN H 18"

399 €
TECKA96

Aluminium blanc,
Teck massif à la finition Duratek®,
White aluminum,
Duratek® finish solid teak

1pc/1box 0,041 m³
4 kg

LANterne TECKALU
65 CM
TECKALU GARDEN LANTERN H 26"

439 €
TECKA97

Aluminium blanc,
Teck massif à la finition Duratek®,
White aluminum,
Duratek® finish solid teak

1pc/1box 0,056 m³
4,5 kg

GRANDE LANterne TECKALU
90 CM
TECKALU BIG LANTERN 35.4"

499 €
TECKA98

Aluminium blanc,
Teck massif à la finition Duratek®,
White aluminum,
Duratek® finish solid teak

1pc/1box 0,068 m³
5 kg

LANTERNES À POSER SOLAIRES ET RECHARGEABLES ☀️
SOLAR AND RECHARGEABLE LANTERNS



LANterne TECKALU
36 CM
TECKALU GARDEN LANTERN H 14"

369 €
TECKA80

Aluminium noir,
Teck massif à la finition Duratek®,
Black aluminum,
Duratek® finish solid teak

1pc/1box 0,034 m³
3,5 kg

LANterne TECKALU
45 CM
TECKALU GARDEN LANTERN H 18"

399 €
TECKA81

Aluminium noir,
Teck massif à la finition Duratek®,
Black aluminum,
Duratek® finish solid teak

1pc/1box 0,041 m³
4 kg

LANterne TECKALU
65 CM
TECKALU garden lantern h 26"

439 €
TECKA82

Aluminium noir,
Teck massif à la finition Duratek®,
Black aluminum,
Duratek® finish solid teak

1pc/1box 0,056 m³
4,5 kg

GRANDE LANterne TECKALU
90 CM
TECKALU BIG LANTERN 35.4"

499 €
TECKA83

Aluminium noir,
Teck massif à la finition Duratek®,
Black aluminum,
Duratek® finish solid teak

1pc/1box 0,068 m³
5 kg

LAMPE DE TABLE SOLAIRE ET RECHARGEABLE ☀️

SOLAR AND RECHARGEABLE TABLE LIGHT



LAMPE DE TABLE TECKALU
TECKALU TABLE LIGHT

198 €
TECKA71
Blanc, White

198 €
TECKA70
Noir, Black

Aluminium,
Teck massif à la finition Duratek®,
Aluminum,
Duratek® finish solid teak

1pc/1box 0,013 m³
1,2 kg



ACCESSOIRE

APPURTENANCE



PATTE DE FIXATION
POUR TECKALU ET TECKINOX
FIXING BRACKET FOR TECKALU AND TECKINOX

TINKAPF 17 €
1pc/1box 0,00007 m³
0,052 kg

IMPLANTATION LUX / DISTANCE TEST RÉALISÉ AVEC
UNE LAMPE TECKA98 500 LM

500 LM	Espace PMR	Espace non PMR
H 0,90 m	2,50 m	3,00 m

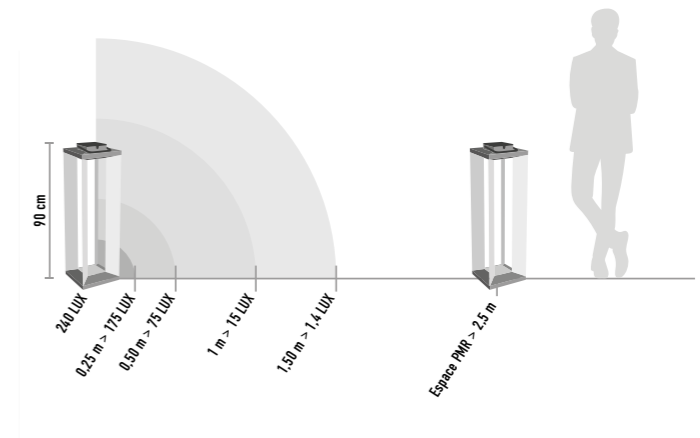

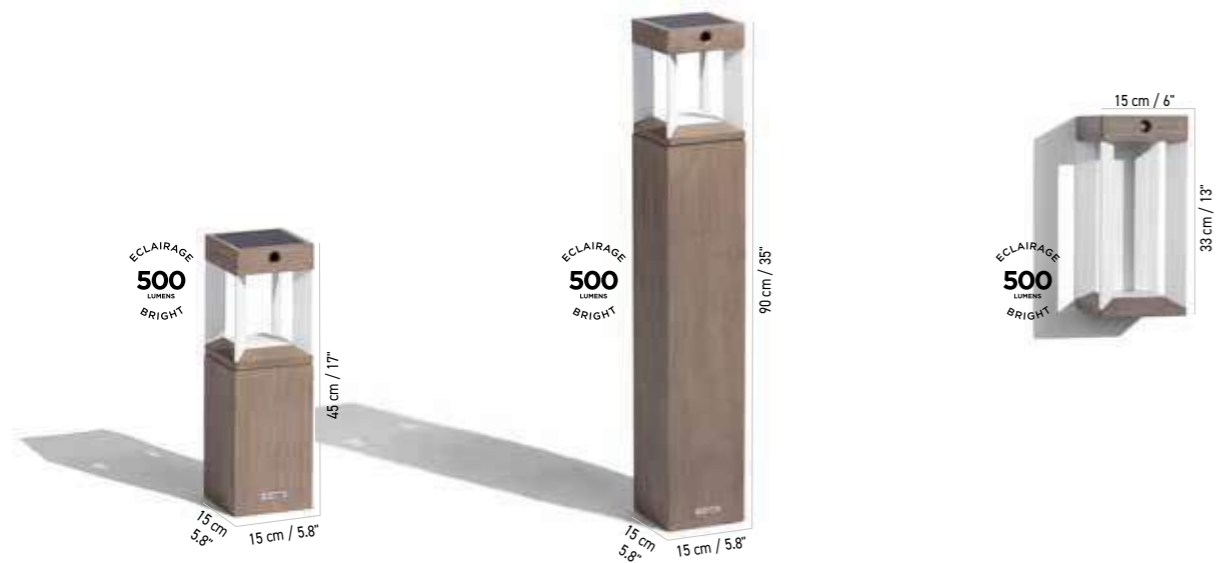



BORNE TECKALU
À SCELLER OU À PLANTER
TECKALU PATHWAY LIGHT
TO BE SEALED OR TO PLANT

 399 €	 399 €
Blanc, White	Noir, Black

Aluminium,
Teck massif à la finition Duratek®,
Aluminium,
Duratek® finish solid teak





BORNE TECKALU
À SCELLER OU À PLANTER
TECKALU PATHWAY LIGHT
TO BE SEALED OR TO PLANT

 549 €	 549 €
Blanc, White	Noir, Black

Aluminium,
Teck massif à la finition Duratek®,
Aluminium,
Duratek® finish solid teak



APPLIQUE MURALE TECKALU
CORNER WALL LIGHT

 299 €	 299 €
Blanc, White	Noir, Black

Aluminium,
Teck massif à la finition Duratek®,
Aluminium,
Duratek® finish solid teak

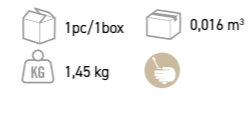

✚ Livrée avec fixation pour sols meubles / Soft ground mounting kit included





TABLE BASSE LUMINEUSE TECKALU
TECKALU ILLUMINATED LOW TABLE

 **789 €**
dont éco-part. 1,50 €
TA04601

Aluminium blanc, HPL béton ciré,
Teck massif à la finition Duratek®,
plaque en verre dépoli acrylique
White aluminum, white wash concrete
HPL, Duratek® finish solid teak, acrylic
frosted glass plate

 **789 €**
dont éco-part. 1,50 €
TA04600

Aluminium noir, HPL ardoise,
Teck massif à la finition Duratek®,
plaque en verre dépoli acrylique
Black aluminum, slat grey HPL,
Duratek® finish solid teak,
acrylic frosted glass plate



 1pc/2boxes  0,096 m³
 15 kg 







TABLE BASSE LUMINEUSE TECKALU
TECKALU ILLUMINATED LOW TABLE

 **789 €**
dont éco-part. 1,50 €
TA04701

Aluminium blanc, HPL béton ciré,
Teck massif à la finition Duratek®,
plaque en verre dépoli acrylique
White aluminum, white wash concrete
HPL, Duratek® finish solid teak, acrylic
frosted glass plate

 **789 €**
dont éco-part. 1,50 €
TA04700

Aluminium noir, HPL ardoise,
Teck massif à la finition Duratek®,
plaque en verre dépoli acrylique
Black aluminum, slat grey HPL,
Duratek® finish solid teak,
acrylic frosted glass plate

 1pc/2boxes  0,090 m³
 15,40 kg 

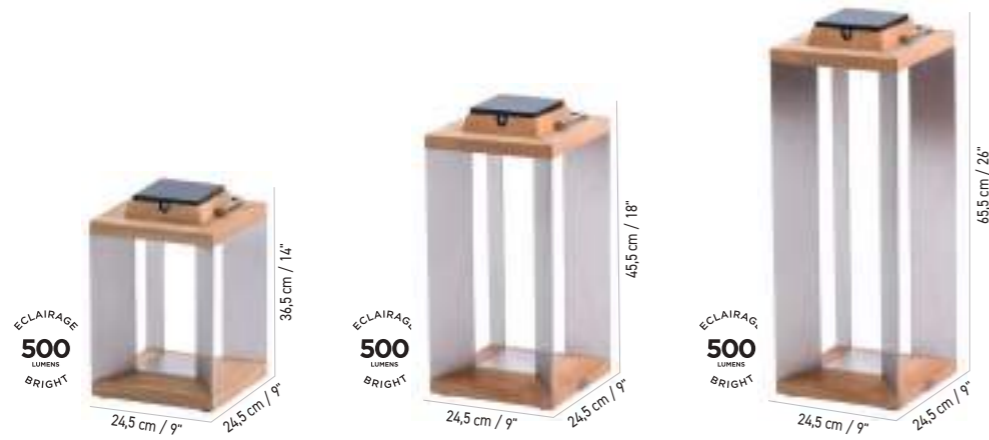

LANTERNE TECKINOX
36 CM
TECKINOX GARDEN LANTERN H 14"

449 €
TECKA60

Acier inoxydable, teck massif*
Stainless steel, solid teak*

1pc/1box 0,029 m³
5 kg

LANTERNE TECKINOX
45 CM
TECKINOX GARDEN LANTERN H 18"

479 €
TECKA61

Acier inoxydable, teck massif*
Stainless steel, solid teak*

1pc/1box 0,036 m³
6 kg

LANTERNE TECKINOX
65 CM
TECKINOX GARDEN LANTERN H 26"

549 €
TECKA62

Acier inoxydable, teck massif*
Stainless steel, solid teak*

1pc/1box 0,051 m³
7 kg

ACCESSOIRE APPURTENANCE



PATTE DE FIXATION
POUR TECKALU ET TECKINOX
FIXING BRACKET
FOR TECKALU AND TECKINOX

TINKAPF 17 €

1pc/1box 0,00007 m³
0,052 kg

IMPLANTATION LUX /DISTANCE TEST RÉALISÉ AVEC
UNE LAMPE TECKA61 500 LM

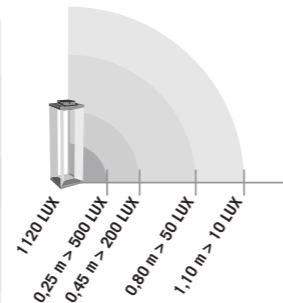

* Teck massif grade AB. Solid teak grade AB.





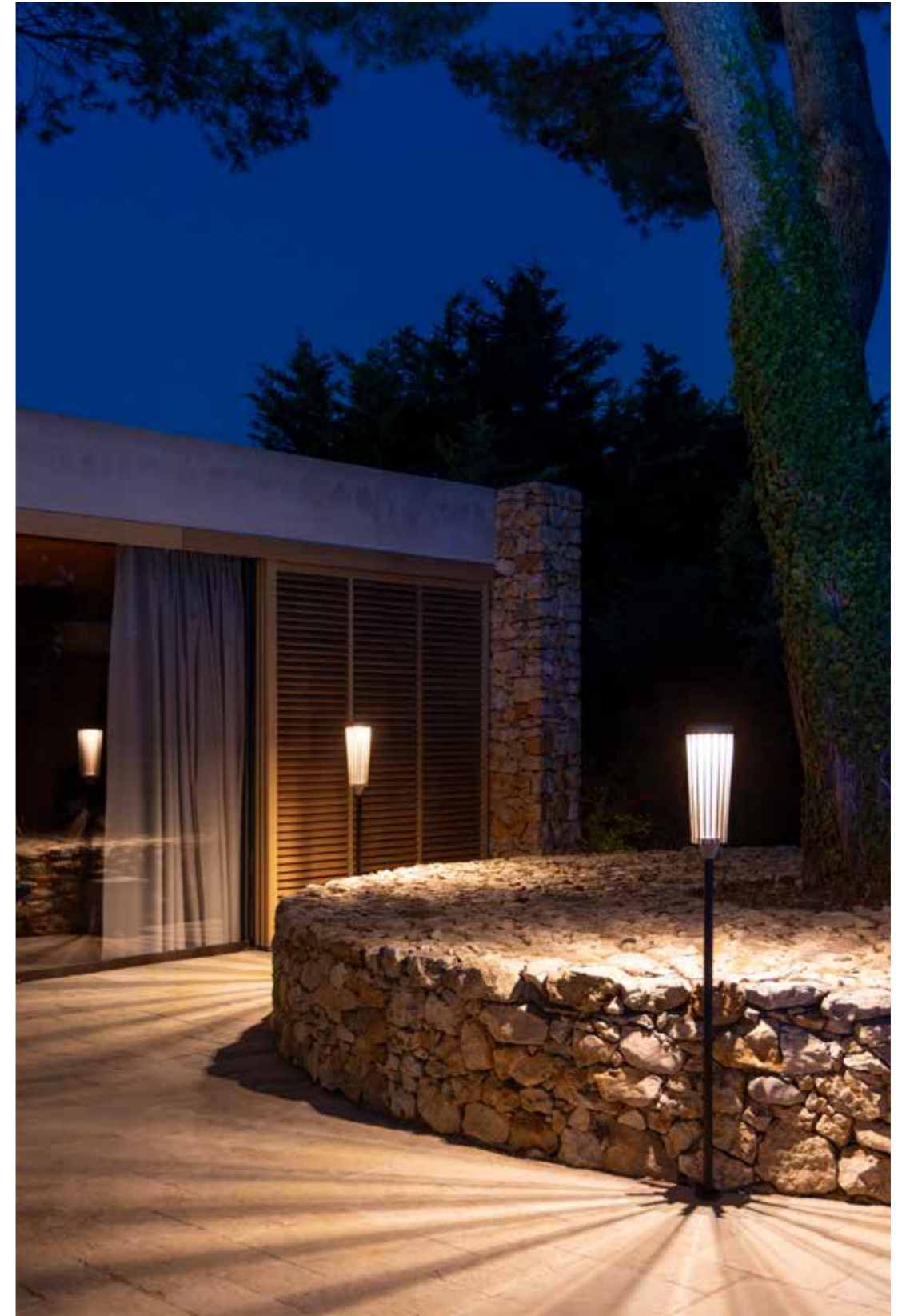

TECKA LAMPADAIRES SOLAIRES ET RECHARGEABLES 
SOLAR AND RECHARGEABLE LAMPPOSTS 



LAMPADAIRE TECKA
TECKA LAMPPOST



 **TECK65B 879 €**

Teck massif
Solid teak

 **TECK85B 979 €**

Teck massif à la finition Duratek®
Duratek® finish solid teak

 1pc/1box  0,39 m³

 9 kg 





OPTION POSSIBLE :
BASE PIERRE TECKA
POUR LAMPADAIRE
POSSIBLE OPTION STONEBASE
FOR LAMPPOST TECKA

 **BLP6585 179 €**

Pierre
Stone

 1pc/1box  0,008 m³

 11 kg 

TECKA

LANTERNES ET TABLES BASSES LUMINEUSES
SOLAIRES ET RECHARGEABLES

SOLAR AND RECHARGEABLE LANTERNS AND ILLUMINATED LOW TABLES



LANTERNE TECKA
TECKA LANTERN

179 €
TECK146

Teck massif* ou Teck massif à la finition Duratek®, verre dépoli acrylique, poignée noire
Solid teak* or Duratek® finish solid teak, acrylic frosted glass, black handle

179 €
TECK147

4 pcs/1box 0,015 m³
1,2 kg



TABLE BASSE LUMINEUSE TECKA (PETIT MODÈLE)
TECKA LOW TABLE LIGHTING (SMALL SIZE)

599 €
TA04500A

Teck massif à la finition Duratek®, HPL ardoise, plaque en verre dépoli acrylique
Duratek® finish solid teak, slate grey HPL, acrylic plate frosted glass

1pc/1box 0,127 m³
5,5 kg



LANTERNE TECKA
TECKA LANTERN

239 €
TECK148

Teck massif* ou Teck massif à la finition Duratek®, verre dépoli acrylique, poignée noire
Solid teak* or Duratek® finish solid teak, acrylic frosted glass, black handle

239 €
TECK149

4 pcs/1box 0,025 m³
2,5 kg



TABLE BASSE LUMINEUSE TECKA (GRAND MODÈLE)
TECKA LOW TABLE LIGHTING (LARGE SIZE)

849 €
TA04503

Teck massif à la finition Duratek®, HPL ardoise, plaque en verre dépoli acrylique
Duratek® finish solid teak, slate grey HPL, acrylic plate frosted glass

1pc/2boxes 0,214 m³
9 kg

TORCHES SOLAIRES ET RECHARGEABLES

SOLAR AND RECHARGEABLE GARDEN TORCH



À commander avec TINKA59
To order with TINKA59

APPLIQUE / TORCHE TECKA®
TECKA GARDEN TORCH

289 €
TECKA68

Teck massif*, verre dépoli acrylique
Solid teak*, acrylic frosted glass

299 €
TECKA88

Teck massif à la finition Duratek®, verre dépoli acrylique
Duratek® finish solid teak, acrylic frosted glass

1pc/1box 0,022 m³
1,5 kg



TORCHE TECKA®
TECKA GARDEN TORCH.

399 €
TECKA66

Teck massif*, verre dépoli acrylique
Solid teak*, acrylic frosted glass

419 €
TECKA86

Teck massif à la finition Duratek®, verre dépoli acrylique
Duratek® finish solid teak, acrylic frosted glass

1pc/1box 0,045 m³
4 kg



TORCHE TECKA®
À PLANTER OU À SCELLER 2 HAUTEURS AJUSTABLES
TECKA GARDEN TORCH
TO PLANT, TWO ADJUSTABLE HEIGHTS

398 €
TECKA89

Aluminium noir, Teck massif à la finition Duratek®, Black aluminum, Duratek® finish solid teak

1pc/1box 0,034 m³
6 kg

+ Livrée avec fixation pour sols meubles
Soft ground mounting kit included

ACCESSOIRES APPURTENANCES

SUPPORT MURAL TINKA POUR TORCHES TECKA ET TINKA
TINKA WALL SUPPORT FOR TECKA AND TINKA TORCH
TINKA59 39 €

1pc/1box 0,003 m³
0,5 kg



SOCLE TINKA Ø 30 CM POUR TORCHES TECKA ET TINKA
TINKA BASE DIAM. 11,6" FOR TECKA AND TINKA TORCH
TINKA56 89 €

1pc/1box 0,02 m³
2,35 kg



* Teck massif grade AB. Solid teak grade AB.

* Teck massif grade AB. Solid teak grade AB.

VERTI

LAMPE DE TABLE SOLAIRE ET RECHARGEABLE ☀️
SOLAR AND RECHARGEABLE TABLE LIGHT



LAMPE DE TABLE VERTI
VERTI TABLE LIGHT

TECKA72 179 €

Teck massif à la finition Duratek®
Duratek® finish solid teak

1pc/1box 0,008 m³
1 kg

ALBA

LAMPE SOLAIRE ET RECHARGEABLE ☀️
SOLAR AND RECHARGEABLE LIGHT



LAMPE ALBA
ALBA LAMP

589 €
TECKA77

Aluminium muscade, Teck massif
à la finition Duratek®, granit beige
Muscade aluminum, Duratek® finish
solid teak, beige granit

1 pc/2boxes 0,077 m³
12,65 kg



SKAAL

Design by Claude Robin

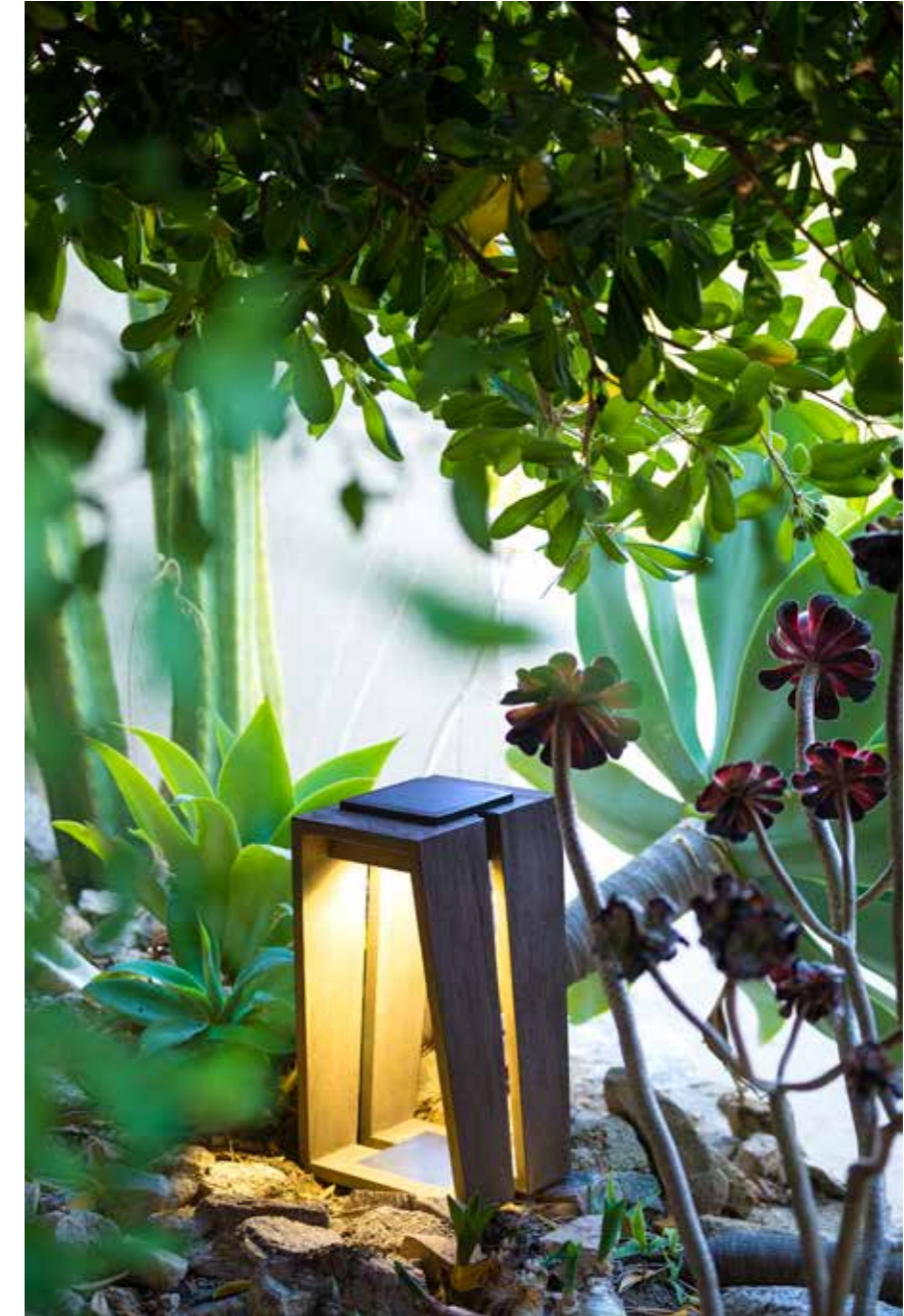

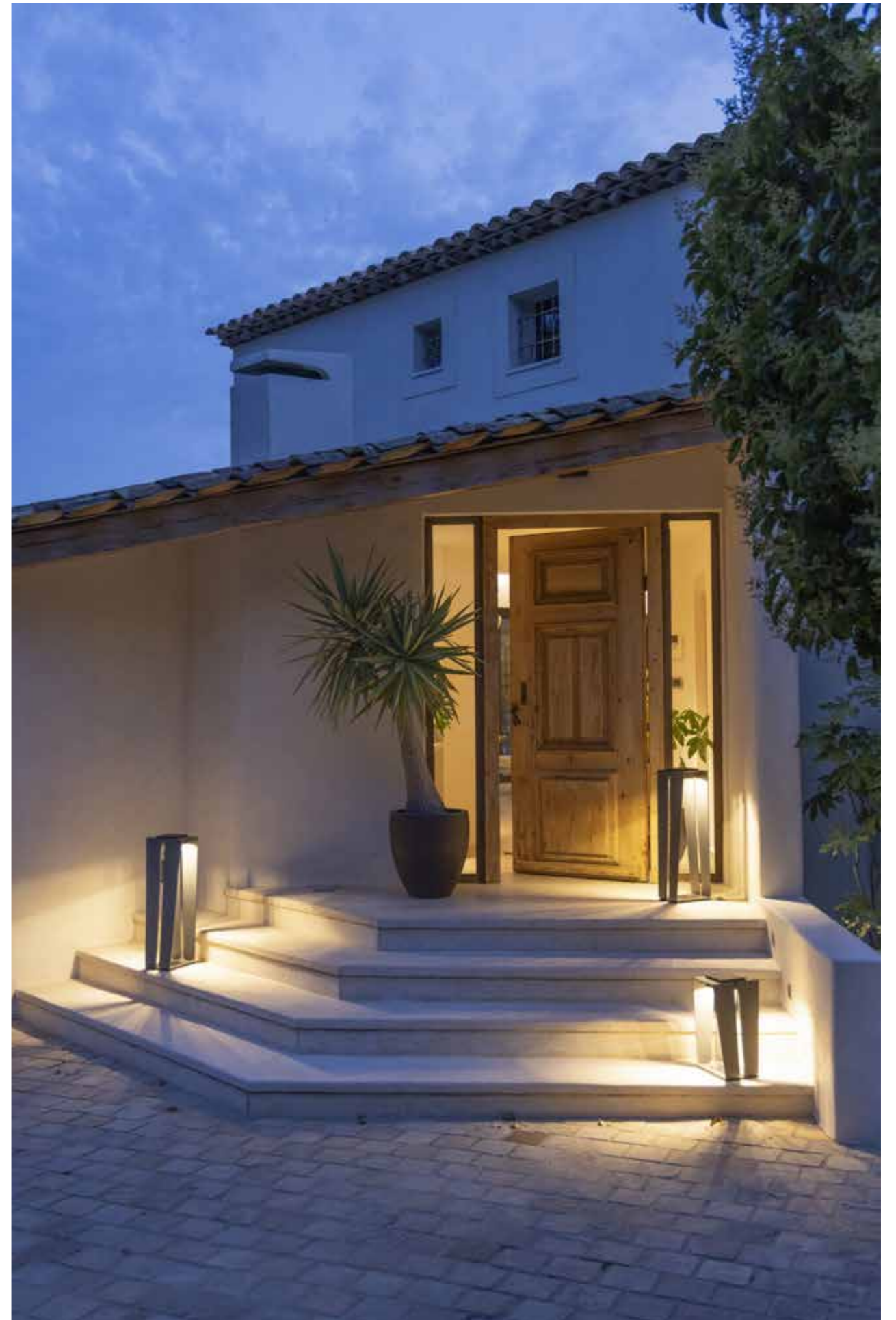





LANTERNE SKAAL
40 CM
SKAAL LANTERN H 15.6"

 TINK120 319 €

Teck massif à la finition Duratek®
Duratek® finish solid teak

 1pc/1box  0,039 m³
 2 kg 

LANTERNE SKAAL
70 CM
SKAAL LANTERN H 27"

 TINK121 419 €

Teck massif à la finition Duratek®
Duratek® finish solid teak



 1pc/1box  0,043 m³
 3 kg 

LANTERNE SKAAL
40 CM
SKAAL LANTERN H 15.6"

 TINK125 319 €
Gris espace, Space grey

 TINK127 319 €
Couleur Corten, Corten color

Aluminium
Aluminum

 1pc/1box  0,039 m³
 1,7 kg 

LANTERNE SKAAL
70 CM
SKAAL LANTERN H 27"

 TINK126 419 €
Gris espace, Space grey

 TINK128 419 €
Couleur Corten, Corten color

Aluminium
Aluminum

 1pc/1box  0,043 m³
 3 kg 



ABAT-JOUR ROP&STRIP
ROP&STRIP LAMPSHADE

 469 €
TECK124

Aluminium muscade,
corde ronde beige chiné
Muscade aluminum,
beige mottled round rope

 1pc/1box  0,107 m³
 2 kg 

ENSEMBLE POTENCE SKAAL
SKAAL POTENCE COMPLETE KIT
TINKA69 + TECK127

 600 €
TINKA69





Teck massif à la finition Duratek®,
base en pierre de lave,
aluminium gris espace
Duratek® finish solid teak,
lava stone, space grey aluminum

 1pc/2boxes  0,084 m³
 50 kg 

ABAT-JOUR SKAAL POUR POTENCE
EN DURATEK® (peut être vendu seul)
LAMPSHADE FOR SKAAL FLOOR LAMP IN TEAK
WITH DURATEK TREATMENT
(can be sold alone)

 TECK127 399 €

Teck massif à la finition Duratek®
Duratek® finish solid teak

 1pc/1box  0,107 m³
 4 kg 

TEKURA

Design by Claude Robin







LAMPE DE TABLE TEKURA
TEKURA TABLE LIGHT

169 €
TECK400

Teck massif, HPL ardoise
Solid teak, Slate grey HPL

1pc/1box 0,008 m³
2 kg

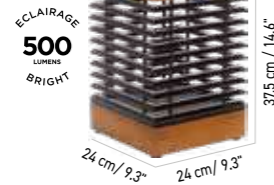

LANTERNE TEKURA 37 CM
TEKURA LIGHT H 14,6"

329 €
TECK410N

Teck massif, HPL ardoise
Solid teak, Slate grey HPL

1pc/1box 0,037 m³
4 kg



LANTERNE TEKURA 46,5 CM
TEKURA LIGHT H 18"

369 €
TECK411N

Teck massif, HPL ardoise
Solid teak, Slate grey HPL

1pc/1box 0,045 m³
5,3 kg

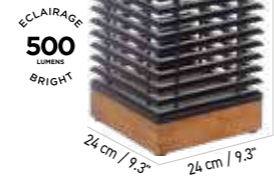

LANTERNE TEKURA 66,5 CM
TEKURA LIGHT H 26,1"

429 €
TECK412N

Teck massif, HPL ardoise
Solid teak, Slate grey HPL

1pc/1box 0,060 m³
7,1 kg



BORNE TEKURA
À planter ou à sceller
TEKURA PATHWAY LIGHT
TO BE SEALED OR TO PLANT

389 €
TECK404N

Teck massif, HPL ardoise
Solid teak, Slate grey HPL

1pc/1box 0,014 m³
6,5 kg



BORNE TEKURA
À planter ou à sceller
TEKURA PATHWAY LIGHT
TO BE SEALED OR TO PLANT

409 €
TECK401N

Teck massif, HPL ardoise
Solid teak, Slate grey HPL

1pc/1box 0,031 m³
7,3 kg

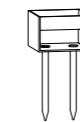

BORNE TEKURA
À planter ou à sceller
TEKURA PATHWAY LIGHT
TO BE SEALED OR TO PLANT

429 €
TECK403N

Duratek**, HPL ardoise
Duratek**, Slate grey HPL

1pc/1box 0,031 m³
7,3 kg

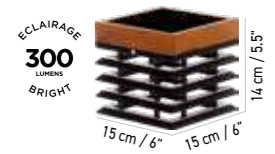

APPLIQUE MURALE TEKURA
TEKURA WALL LIGHT

159 €
TECK402N

Teck massif, HPL ardoise
Solid teak, Slate grey HPL

1pc/1box 0,006 m³
1 kg

+ Livrée avec fixation pour sols meubles / Soft ground mounting kit included



PASTEK

TABLE BASSE ET LAMPE SOLAIRE ET RECHARGEABLE ☀️

SOLAR AND RECHARGEABLE ILLUMINATED LOW TABLE AND LIGHT ☀️



LAMPE PASTEK
PASTEK LIGHT

269 €
TINK430

Teck massif, HPL ardoise
Solid teak, slate grey HPL

1pc/1box 0,055 m³
6,15 kg



TABLE BASSE LUMINEUSE PASTEK
PASTEK ILLUMINATED LOW TABLE

689 €
TA00430

HPL ardoise, granite, plaque en verre dépoli acrylique
HPL slate grey, granit, acrylic frosted glass plate

1pc/3 boxes 0,117 m³
18,65 kg



ROP&STRIP



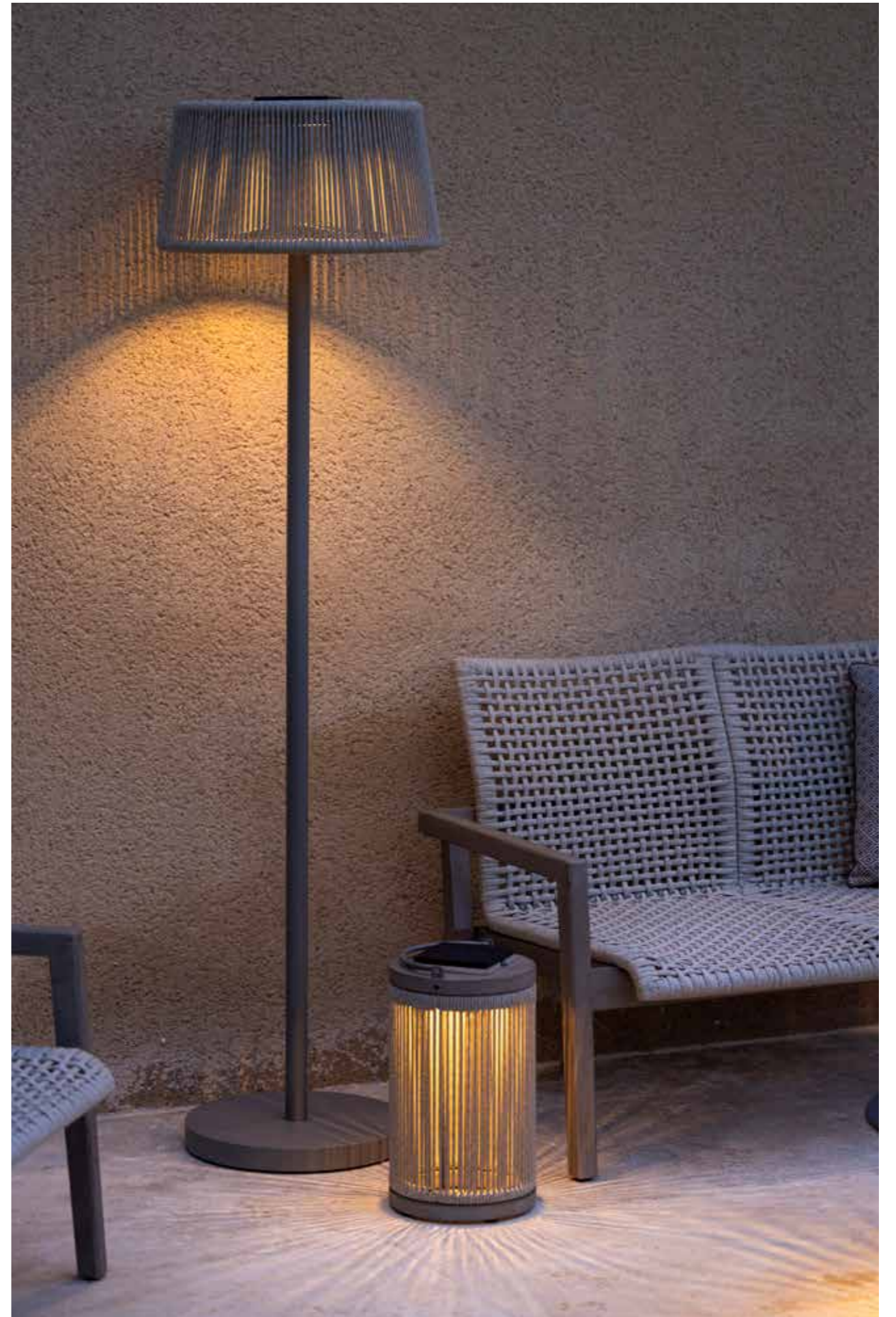

ROP&STRIP

LAMPE DE TABLE, ABAT-JOUR, LANTERNES
ET LAMPADAIRES SOLAIRES ET RECHARGEABLES

SOLAR AND RECHARGEABLE TABLE LIGHT, LAMPSHADE, LANTERNS AND LAMPPOSTS

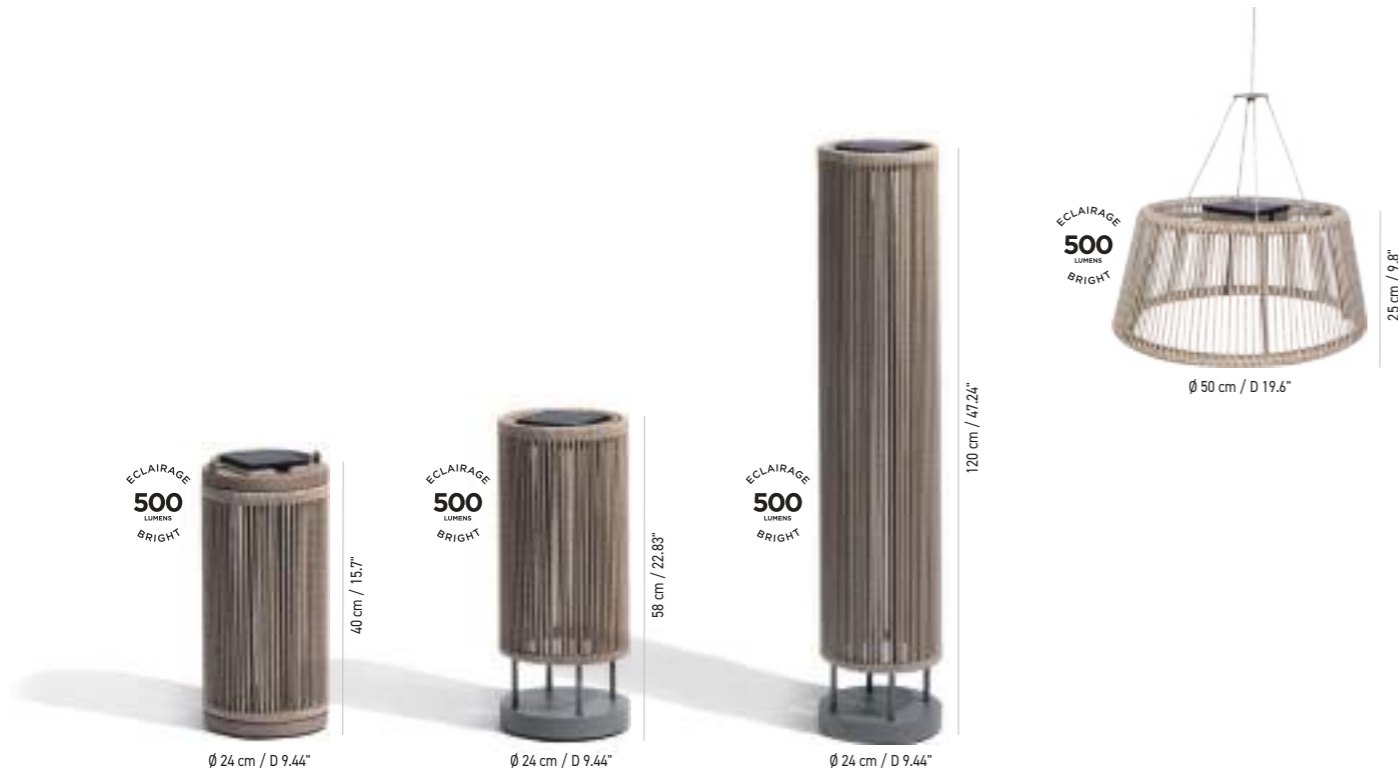

LANTERNE ROP&STRIP
ROP&STRIP LANTERN

389 €
TECK062

Aluminium muscade,
Teck massif à la finition Duratek®,
corde ronde beige chiné
Muscade aluminium,
Duratek® finish solid teak,
beige mottled round rope

1 pc/1box 0,046 m³
2,4 kg

LAMPE ROP&STRIP
ROP&STRIP LIGHT

449 €
TECK060

Aluminium muscade,
corde ronde beige chiné
Muscade aluminium,
beige mottled round rope

1 pc/2boxes 0,060 m³
6,4 kg

LAMPADAIRE ROP&STRIP
ROP&STRIP LAMPPOST

589 €
TECK061

Aluminium muscade,
corde ronde beige chiné
Muscade aluminium,
beige mottled round rope

1 pc/2boxes 0,106 m³
7,25 kg

ABAT-JOUR ROP&STRIP
ROP&STRIP LAMPSHADE

469 €
TECK124

Aluminium muscade,
corde ronde beige chiné
Muscade aluminium,
beige mottled round rope

1 pc/1box 0,107 m³
2 kg



LAMPADAIRE ROP&STRIP
REGLABLE 2 HAUTEURS (120/175)
ROP&STRIP LAMPPOST
ADJUSTABLE HIGH

759 €*
TECKA93

Aluminium muscade,
corde ronde beige chiné
Muscade aluminium,
beige mottled round rope

new//
759 €*
TINK093

Aluminium noir,
corde ronde noir chiné
Black aluminum,
black mottled round rope

1 pc/2boxes 0,293 m³
12,95 kg

* Prix valable pour une lampe équipée d'un module 500 lumens. Price valid for a lamp equipped with a 500-lumen module.



LAMPE DE TABLE ROP&STRIP
ROP&STRIP TABLE LAMP

269 €
TINK062

Teck massif noir,
corde ronde noir chiné
Black solid teak, black mottled
round rope

269 €
TECK063

Teck massif à la finition Duratek®,
corde ronde beige chiné,
Aluminium muscade
Duratek® finish solid teak,
beige mottled round rope,
muscade aluminum

1pc/1box 0,018 m³
1,65 kg

LANterne ROP&STRIP
ROP&STRIP LANTERN

409 €*
TINK064

Granit noir, corde ronde
noir chiné, aluminium noir
Black granite, black mottled
round rope, black aluminum

409 €*
TECK064

Granit Duratek®,
corde ronde beige chiné,
Aluminium muscade
Duratek® granite,
beige mottled round rope,
muscade aluminum

1pc/1box 0,061 m³
9,2 kg

LANterne ROP&STRIP
ROP&STRIP LANTERN

469 €*
TINK065

Granit noir, corde ronde
noir chiné, aluminium noir
Black granite, black mottled
round rope, black aluminum

469 €*
TECK065

Granit Duratek®,
corde ronde beige chiné,
Aluminium muscade
Duratek® granite,
beige mottled round rope,
muscade aluminum

1 pc/2boxes 0,083 m³
9,9 kg

LANterne ROP&STRIP
ROP&STRIP LANTERN

569 €*
TINK066

Granit noir, corde ronde
noir chiné, aluminium noir
Black granite, black mottled
round rope, black aluminum

569 €*
TECK066

Granit Duratek®,
corde ronde beige chiné,
Aluminium muscade
Duratek® granite,
beige mottled round rope,
muscade aluminum

1 pc/2boxes 0,108 m³
10,6 kg

* Prix valable pour une lampe équipée d'un module 500 lumens. Price valid for a lamp equipped with a 500-lumen module.

TRADITION







TRADITION

LANTERNES SOLAIRES ET RECHARGEABLES

SOLAR AND RECHARGEABLE LANTERNS 



LANTERNE TRADITION ALUMINIUM
40 CM
TRADITION GARDEN LIGHT
H 15.6"

289 €
TINK230
Gris espace, Space grey

289 €
TINK234
Couleur Corten, Corten color

Aluminium, verre dépoli acrylique
Aluminum, acrylic frosted glass

1pc/1box 0,041 m³
KG 2,5 kg 

LANTERNE TRADITION ALUMINIUM
65 CM
TRADITION GARDEN LIGHT
H 25.4"

399 €
TINK231
Gris espace, Space grey

399 €
TINK235
Couleur Corten, Corten color

Aluminium, verre dépoli acrylique
Aluminum, acrylic frosted glass

1pc/1box 0,064 m³
KG 4,1 kg 

LANTERNE TRADITION TECK
40 CM
TRADITION GARDEN LIGHT IN TEAK
H 15.6"

339 €
TECK232

Aluminium, Teck massif*,
verre dépoli acrylique
Aluminum, Solid teak*,
acrylic frosted glass

1pc/1box 0,041 m³
KG 3 kg 

LANTERNE TRADITION TECK
65 CM
TRADITION GARDEN LIGHT IN TEAK
H 15.6"

419 €
TECK233

Aluminium, Teck massif*,
verre dépoli acrylique
Aluminum, Solid teak*,
acrylic frosted glass

1pc/1box 0,064 m³
KG 4 kg 

ACCESSOIRE APPURTENANCE

PATTE DE FIXATION
TRADITION
Fixing bracket for TRADITION
PFT0001 19 €

1pc/1box 0,006 m³
KG 0,08 kg 

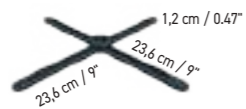

* Teck massif grade AB. Solid teak grade AB.

BORNES SOLAIRES ET RECHARGEABLES

SOLAR AND RECHARGEABLE PATHWAY LIGHTS 

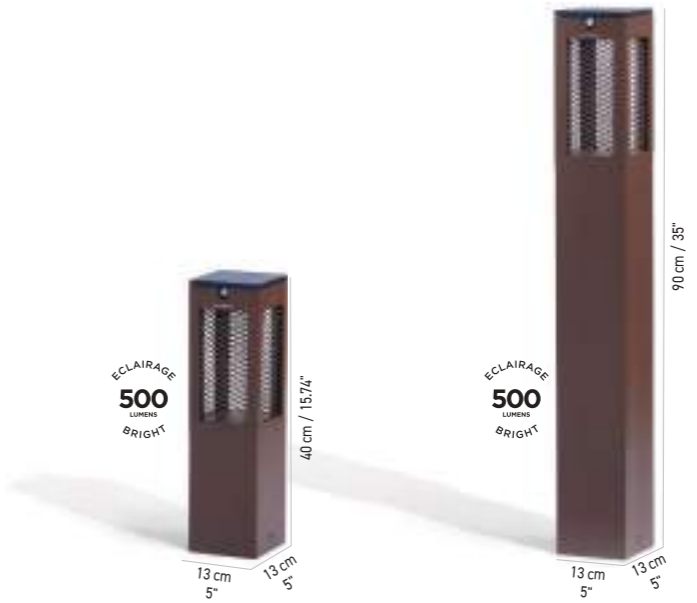

BORNE TRADITION
à sceller ou à planter
TRADITION PATHWAY LIGHT
to be sealed or to plant

TINK180 319 €

Aluminium couleur Corten
Corten color aluminum

1pc/1box 0,013 m³
KG 1,5 kg 



BORNE TRADITION
à sceller ou à planter
TRADITION PATHWAY LIGHT
to be sealed or to plant

TINK181 429 €

Aluminium couleur Corten
Corten color aluminum

1pc/1box 0,023 m³
KG 2,5 kg 



+ Livrée avec fixation pour sols meubles / Soft ground mounting kit included

BATEAK & TYBLE

LAMPES DE TABLE SOLAIRES ET RECHARGEABLES ☀️

SOLAR AND RECHARGEABLE TABLE LIGHTS ☀️

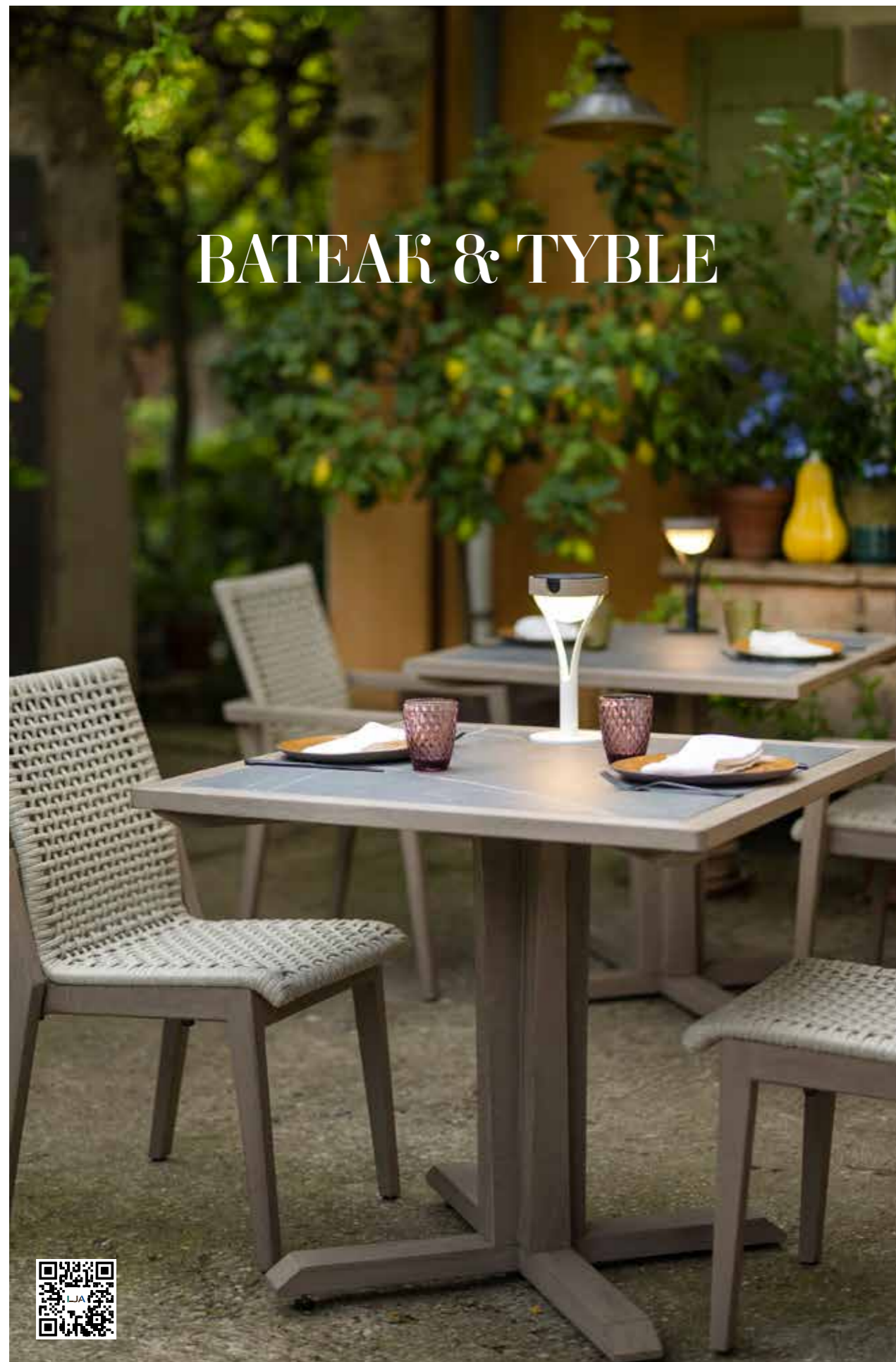

LAMPE DE TABLE TYBLE
TYBLE TABLE LIGHT

189 €
LST0001
Noir, Black

189 €
LST0002
Blanc, White

Aluminium,
Teck massif à la finition Duratek®
Aluminum,
Duratek® finish solid teak

1pc/1box 0,007 m³
1,2 kg



LAMPE DE TABLE BATEAK
BATEAK TABLE LIGHT

169 €
LST0010
Noir, Black

169 €
LST0011
Blanc, White

Aluminium,
Teck massif à la finition Duratek®,
toile Ateja ardoise ou blanche
Aluminum, Duratek® finish solid
teakblack or white Ateja sling

1pc/1box 0,007 m³
1,2 kg



RANCHO

TABLE BASSE LUMINEUSE SOLAIRE ET RECHARGEABLE ☀️
SOLAR AND RECHARGEABLE ILLUMINATED LOW TABLE

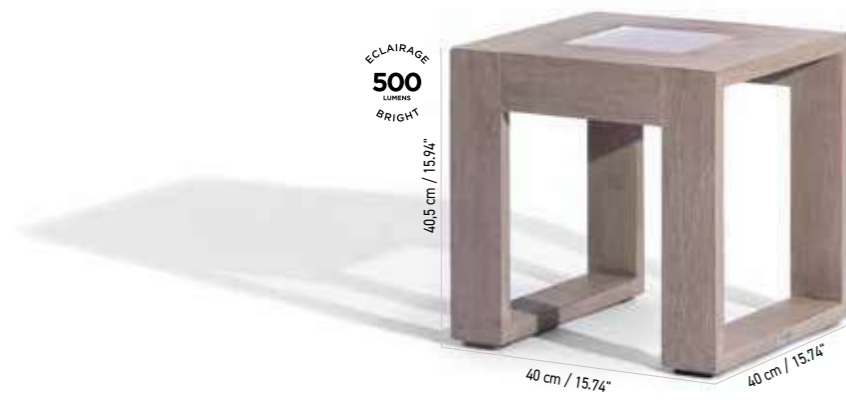

TABLE BASSE LUMINEUSE RANCHO
RANCHO LOW TABLE LIGHTING

529 €
dont éco-part. 0,66 €
TAL2000

Teck massif à la finition Duratek®,
plaque en verre dépoli acrylique
Duratek® finish solid teak,
acrylic plate frosted glass

1pc/1box 0,133 m³
6 kg



BUMP

LANTERNES NOMADES SOLAIRES ET RECHARGEABLES ☀️
SOLAR AND RECHARGEABLE NOMAD LANTERN LIGHTS



LANTERNE BUMP 300 NOMADE
BUMP GARDEN LANTERN

139 € TINK210 Rouge, Red
139 € TINK211 Gris espace, Space grey

Rotomoulé, aluminium
Rotomolded, aluminum

4 pcs/1box 0,01m³
0,9 kg



LANTERNE BUMP 500 NOMADE BUMP
500 GARDEN LANTERN

219 € TINK250 Rouge, Red
219 € TINK251 Gris espace, Space grey

219 € TINK252 Muscade, Muscade

Rotomoulé, aluminium
Rotomolded, aluminum

4 pcs/1box 0,014m³
1,2 kg



LE SOLAIRE made in France

INNOVATION, MATIÈRE ET CRÉATIVITÉ

Chez LES JARDINS®, l'impression 3D s'invite avec audace et modernité. C'est la fusion parfaite d'un design original et d'une technologie solaire avant-gardiste.

Ensemble, ils donnent naissance à une collection de luminaires solaires, un équilibre subtil entre l'artisanat et la production industrielle. De la lampe de table élégante au lampadaire majestueux, découvrez une nouvelle gamme fabriquée à Aix-en-Provence.

Chaque pièce trouve sa raison d'être grâce à nos modules solaires LES JARDINS®.

INNOVATION, MATERIAL, AND CREATIVITY

At LES JARDINS®, 3D printing boldly and modernly makes its mark. It's the perfect fusion of original design and cutting-edge solar technology. Together, they give birth to a collection of solar lights, striking a subtle balance between craftsmanship and industrial production. From elegant table lamps to majestic floor lamps, discover a new range made in Aix-en-Provence.

Each piece finds its purpose thanks to our LES JARDINS® solar modules.











LAMPIONS ET LANTERNES SOLAIRES ET RECHARGEABLES ☀️

SOLAR AND RECHARGEABLE LAMPIONS AND LANTERN LIGHTS ☀️



LAMPION À SUSPENDRE LOLIE LOLIE HANGING LANTERN

129 €



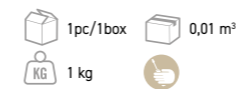

-  TD11L000
-  TD11L001
-  TD11L002
-  TD11L003
-  TD11L004

Aluminium noir, PETG
Black aluminum, PETG



LAMPION LOLIE LOLIE LAMPION

159 €



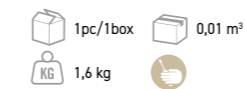

-  TD05L000
-  TD05L001
-  TD05L002
-  TD05L003
-  TD05L004

Aluminium noir, PETG
Black aluminum, PETG



LANterne CARRÉE LOLIE LOLIE SQUARE LANTERN

199 €



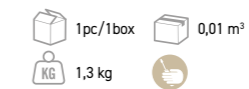

-  TD14L000
-  TD14L001
-  TD14L002
-  TD14L003
-  TD14L004

Aluminium noir, PETG
Black aluminum, PETG



LANterne LOLIE LOLIE LANTERN

349 €

-  TD06L000
-  TD06L001
-  TD06L002
-  TD06L003
-  TD06L004





Aluminium noir, PETG
Black aluminum, PETG





LAMPE DE TABLE LOLIE
LOLIE TABLE LIGHT

159 €



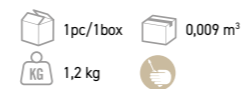

-  TD01L000
-  TD01L001
-  TD01L002
-  TD01L003
-  TD01L004

Aluminium noir, PETG
Black aluminum, PETG



LAMPE DE TABLE LOLIE MINI
LOLIE TABLE LIGHT MINI

159 €



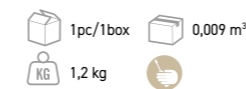

-  TD12L000
-  TD12L001
-  TD12L002
-  TD12L003
-  TD12L004

Aluminium noir, PETG
Black aluminum, PETG



LAMPE LOLIE
LOLIE LAMP LIGHT

229 €



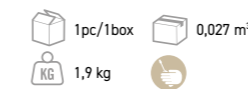

-  TD02L000
-  TD02L001
-  TD02L002
-  TD02L003
-  TD02L004

Aluminium noir, PETG
Black aluminum, PETG



LAMPE DE TABLE PALOMA
PALOMA TABLE LIGHT

159 €

-  TD01D000
-  TD01D001
-  TD01D002
-  TD01D003
-  TD01D004

Aluminium noir, PETG
Black aluminum, PETG

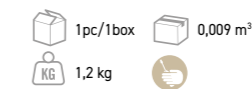

LAMPE ROMY
ROMY LIGHT

229 €

-  TD02D000

Aluminium noir, PETG
Black aluminum, PETG



CRYSTAL

OLIVE

CENDRE

SAFRAN

AMBRE



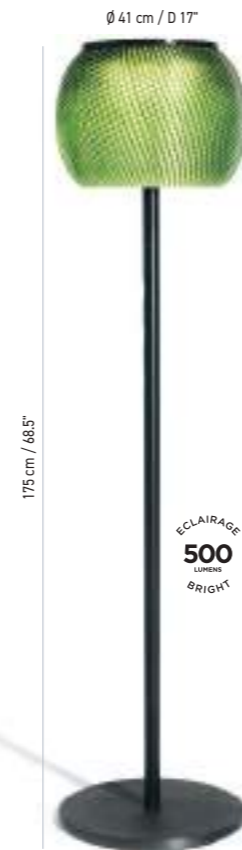

LAMPADAIRES SOLAIRES ET RECHARGEABLES ☀

SOLAR AND RECHARGEABLE LAMPPOST LIGHTS ☀



LAMPADAIRE LOLIE LARGE
LOLIE LARGE LAMPPOST LIGHT

699 €

-  TD04L1000
-  TD04L1001
-  TD04L1002
-  TD04L1003
-  TD04L1004

Aluminium noir, PETG
Black aluminum, PETG

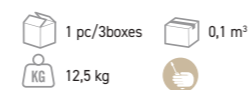





TORCHES SOLAIRES ET RECHARGEABLES ☀

SOLAR AND RECHARGEABLE GARDEN TORCHS AND PATHWAY LIGHTS ☀



TORCHE LOLIE SMALL À PLANTER
LOLIE SMALL GARDEN TORCH
TO PLANT

159 €





-  TD08L1000
-  TD08L1001
-  TD08L1002
-  TD08L1003
-  TD08L1004

Aluminium noir, PETG
Black aluminum, PETG



TORCHE LOLIE MEDIUM À PLANTER
LOLIE MEDIUM GARDEN TORCH
TO PLANT

259 €

-  TD09L1000
-  TD09L1001
-  TD09L1002
-  TD09L1003
-  TD09L1004

Aluminium noir, PETG
Black aluminum, PETG

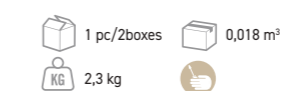

TORCHE LOLIE LARGE À PLANTER
LOLIE LARGE GARDEN TORCH
TO PLANT

349 €

-  TD10L1000
-  TD10L1001
-  TD10L1002
-  TD10L1003
-  TD10L1004

Aluminium noir, PETG
Black aluminum, PETG



KOBRA

BORNES SOLAIRES ET RECHARGEABLES 

SOLAR AND RECHARGEABLE LAMPOSTS 



BORNE KOBRA
KOBRA PATHWAY LIGHT

 **299 €**
TD07K006
Noir, Black

 **299 €**
TD07K007
Couleur Corten, Corten color

Aluminium, PETG,
PETG pailleté
Aluminium, PETG,
glittery PETG

 1 pc/2boxes  0,158 m³
 2,2 kg 

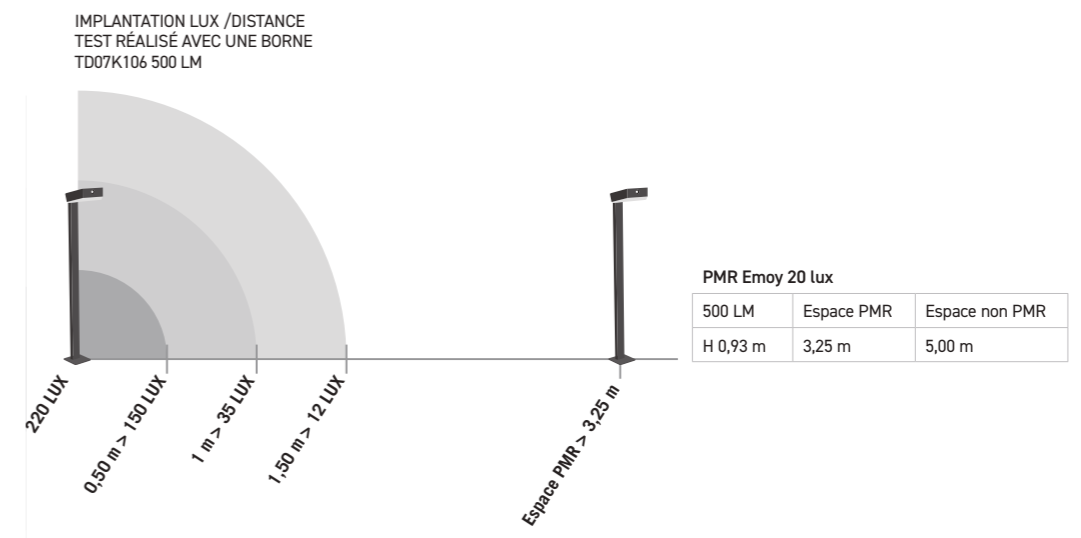

JET STREAM



JET STREAM

TABLES BASSES LUMINEUSES
SOLAIRES ET RECHARGEABLES

SOLAR AND RECHARGEABLE ILLUMINATED LOW TABLES



TABLE BASSE LUMINEUSE JET STREAM
JET STREAM ILLUMINATED LOW TABLE

989 €
dont éco-part. 1,50 €
JSTAL10

Aluminium couleur Corten,
Teck massif à la finition Duratek®,
plaque en verre dépoli acrylique
Corten color aluminum,
Duratek® finish solid teak,
acrylic frosted glass plate

1pc/1box 0,440 m³
15,50 kg

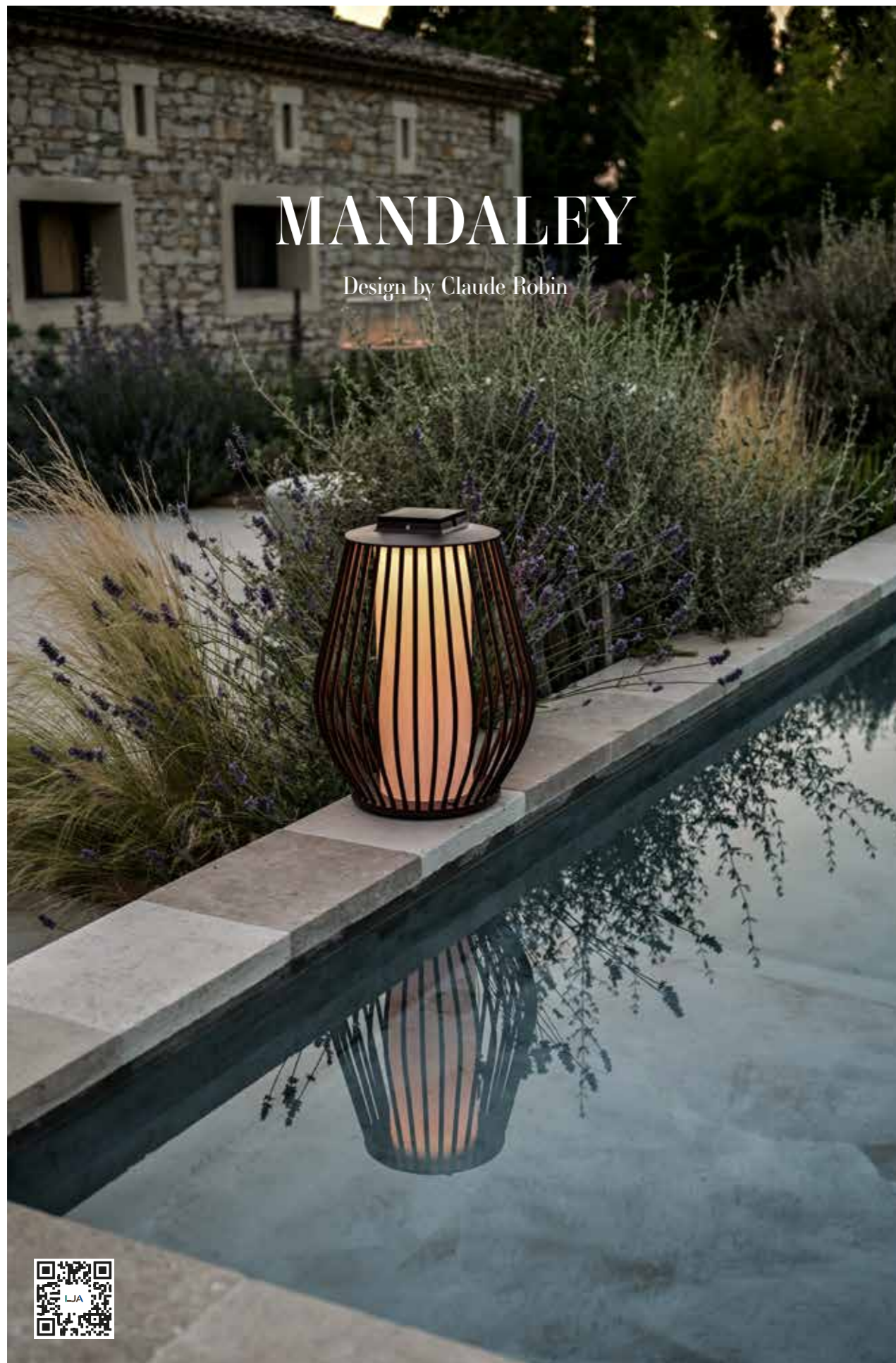

TABLE BASSE LUMINEUSE JET STREAM
JET STREAM ILLUMINATED LOW TABLE

839 €
dont éco-part. 2,20 €
JSTAL11

Aluminium gris espace, HPL béton ciré,
plaque en verre dépoli acrylique, granit
Space grey aluminum, HPL white wash concrete,
acrylic frosted glass plate, granite

1pc/1box 0,117 m³
26,70 kg



MANDALEY

Design by Claude Robin



LANTERNES SOLAIRES ET RECHARGEABLES ☀️

SOLAR AND RECHARGEABLE LANTERNS 🌞



Ø 40 cm / D15.74"

GRANDE LANTERNE MANDALEY MANDALEY BIG LANTERN

TINK600 1499 €
Gris espace, Space grey

TINK601 1499 €
Couleur Corten, Corten color

Aluminium
Aluminum

1pc/1box 0,373 m³

KG 13,30 kg



Ø 40 cm / D15.74"

LANTERNE MANDALEY MANDALEY LANTERN

TINK602 889 €
Gris espace, Space grey

TINK603 889 €
Couleur Corten, Corten color

Aluminium
Aluminum

1pc/1box 0,158 m³

KG 7,55 kg



OSMOZ

Design by Denali

LAMPES SOLAIRE ET RECHARGEABLE ☀️

SOLAR AND RECHARGEABLE LIGHTS ☀️







Osmoz : Design Denali®

LAMPE OSMOZ OSMOZ LIGHT

 **TECK420 899 €***

Teck massif à la finition Duratek®
Duratek® finish solid teak

 1pc/1box  0,121 m³



 8,45 kg 

LAMPE OSMOZ OSMOZ LIGHT

 **TINK421 879 €***
Blanc, White

 **TINK422 879 €***
Gris espace, Space grey

Aluminium
Aluminum

 1pc/1box  0,121 m³



 8,6 kg 

LAMPE OSMOZ OSMOZ LIGHT

 **TINK423 1199 €***
Blanc, White

 **TINK424 1199 €***
Gris espace, Space grey

Aluminium
Aluminum

 1pc/1box  0,211 m³

 11,85 kg 

* Prix valable pour une lampe équipée d'un module 500 lumens. Price valid for a lamp equipped with a 500-lumen module.



SELVA

Design by Denali

LAMPADAIRE SOLAIRE ET RECHARGEABLE 
SOLAR AND RECHARGEABLE LAMPPOST 



LAMPADAIRE SELVA
SELVA LAMPLARGE MODEL

1369 €
TECK502

Teck massif à la finition Duratek®,
toile Ateja blanche
Duratek® finish solid teak,
white sling Ateja

1pc/1box 0,375 m³
13 kg

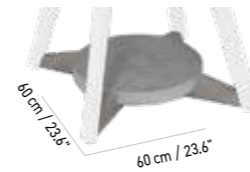

RECOMMANDER : BASE PIERRE
POUR LAMPADAIRE SELVA
POSSIBLE OPTION STONEBASE
FOR LAMPPOST SELVA

189 €
BLP0502

Teck massif à la finition Duratek®,
pierre
Duratek® finish solid teak,
stone

1pc/1box 0,038 m³
7,5 kg

CORNER

Design by 2x5 design

APPLIQUE SOLAIRE ET RECHARGEABLE 
SOLAR AND RECHARGEABLE WALL LIGHT 



APPLIQUE MURALE CORNER
CORNER WALL LIGHT

TINK440 299 €

Aluminium gris espace
Space grey aluminium

1pc/1box 0,015 m³
1,7 kg

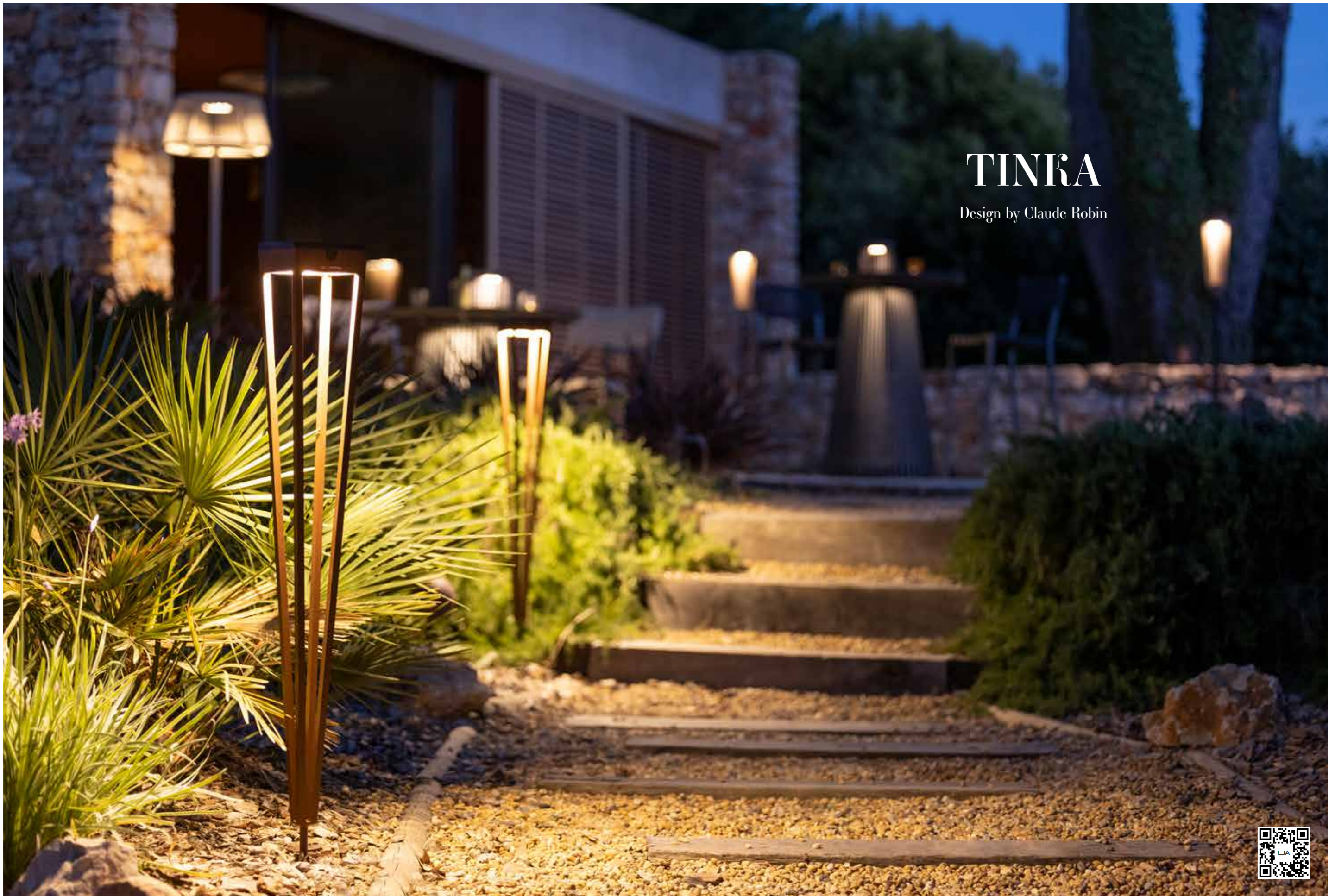

TINKA

Design by Claude Robin







LANterne TINKA®
TINKA® GARDEN LANTERN

- 179 €**
TINK140
Couleur Corten, Corten color
- 179 €**
TINK136
Rouge, Red
- 179 €**
TINK137
Muscade, Muscade
- 179 €**
TINK138
Gris espace, Space grey
- 179 €**
TINK139
Blanc, White

Aluminium, verre dépoli acrylique
Aluminum, acrylic frosted glass



+ Toutes les torches 500 lumens peuvent être positionnées sur socle.
Every 500 lumens torches can be used with the base.

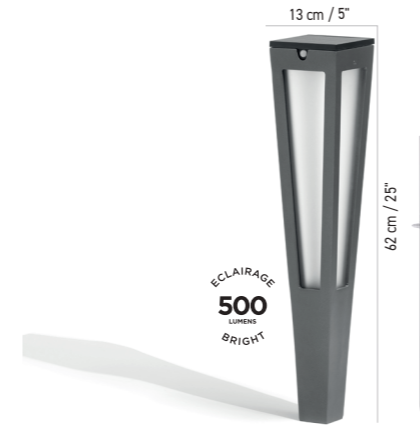

APPLIQUE / TORCHE TINKA®
Livrée avec pic à planter en inox
TINKA® MINI TORCH
DELIVERED WITH INOX SPIKE
TO PLANT.

- TINKA47 319 €**
Gris espace, Space grey
- TINKA39 319 €**
Couleur Corten, Corten color
- TINKA63 319 €**
Blanc, White

Aluminium, verre dépoli acrylique
Aluminum, acrylic frosted glass



TORCHE TINKA®
Livrée avec pic à planter en inox
TINKA® MINI TORCH
DELIVERED WITH INOX SPIKE
TO PLANT.

- TINKA27 429 €**
Gris espace, Space grey
- TINKA19 429 €**
Couleur Corten, Corten color

Aluminium, verre dépoli acrylique
Aluminum, acrylic frosted glass

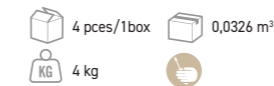

TORCHE TINKA®
AVEC PIC INTÉGRÉ
TINKA® GARDEN TORCH
WITH SPIKE

- TINKA57 198 €**
Gris espace, Space grey
- TINKA64 198 €**
Couleur Corten, Corten color
- TINKA62 198 €**
Blanc, White

Aluminium
Aluminum

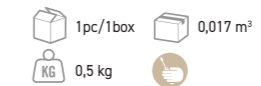

TORCHE TINKA®
AVEC PIC INTÉGRÉ
TINKA® GARDEN TORCH
WITH SPIKE

- TINKA53 269 €**
Gris espace, Space grey
- TINKA54 269 €**
Couleur Corten, Corten color

Aluminium
Aluminum



IMPLANTATION PMR
POUR UNE TORCHE TINKA53 OPTION 500 LM

PMR Emoy 20 lux		
500 LM	Espace PMR	Espace non PMR
H 0,90 m	3,00 m	4,50 m

ACCESSOIRES APPURTENANCES

SUPPORT MURAL TINKA
POUR TORCHES TECKA ET TINKA
TINKA WALL SUPPORT
FOR TECKA AND TINKA TORCH
TINKA59 39 €

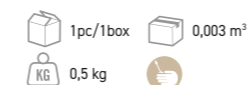

SOCLE TINKA Ø 30 CM
POUR TORCHES TECKA ET TINKA
TINKA BASE DIAM. 11,8"
FOR TECKA AND TINKA TORCH
TINKA56 89 €



BLADE

Design by Claude Robin



BORNES ET APPLIQUES SOLAIRES ET RECHARGEABLES ☀️

SOLAR AND RECHARGEABLE PATHWAYS AND WALL LIGHTS ☀️



BORNE BLADE À FIXER
BLADE PATHWAY LIGHT TO FIX

TINK170 249 €
Gris espace, Space grey

TINK172 249 €
Couleur Corten, Corten color

Aluminium
Aluminum

1pc/1box 0,013 m³
1,5 kg



BORNE BLADE À FIXER
BLADE PATHWAY LIGHT TO FIX

TINK171 309 €
Gris espace, Space grey

TINK173 309 €
Couleur Corten, Corten color

Aluminium
Aluminum

1pc/1box 0,023 m³
2,5 kg



APPLIQUE MURALE BLADE
BLADE WALL LIGHT

TINK445 239 €
Gris espace, Space grey

TINK446 239 €
Couleur Corten, Corten color

Aluminium
Aluminum

1pc/1box 0,009 m³
1,3 kg

IMPLANTATION PMR
POUR UNE BORNE TINK171 500 LM

PMR Emoy 20 lux

500 LM	Espace PMR	Espace non PMR
H 0,90 m	3,00 m	4,50 m



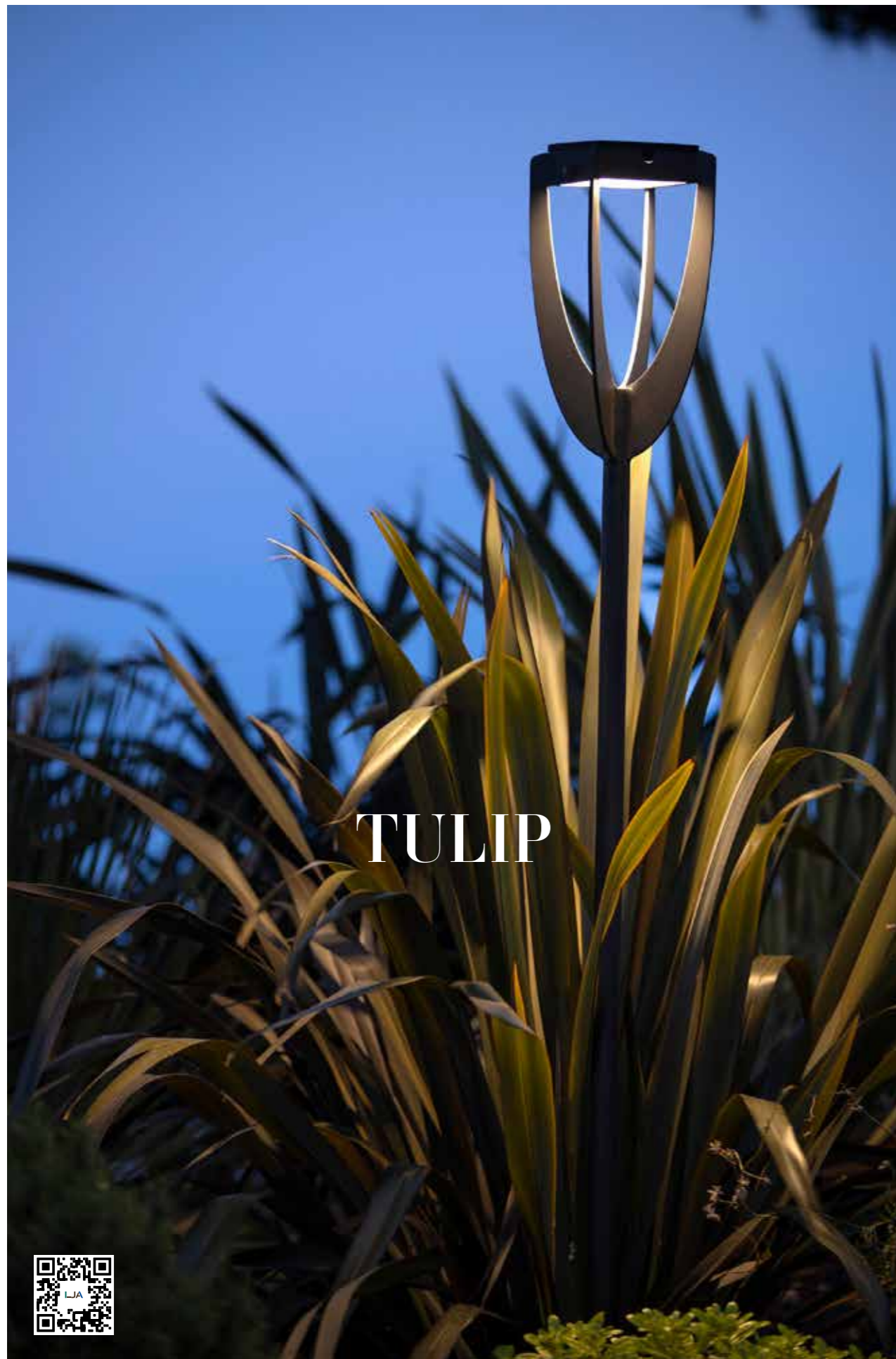

LAMPES ET TORCHES SOLAIRES ET RECHARGEABLES ☀

SOLAR AND RECHARGEABLE PATHWAYS AND TORCH LIGHTS ☀

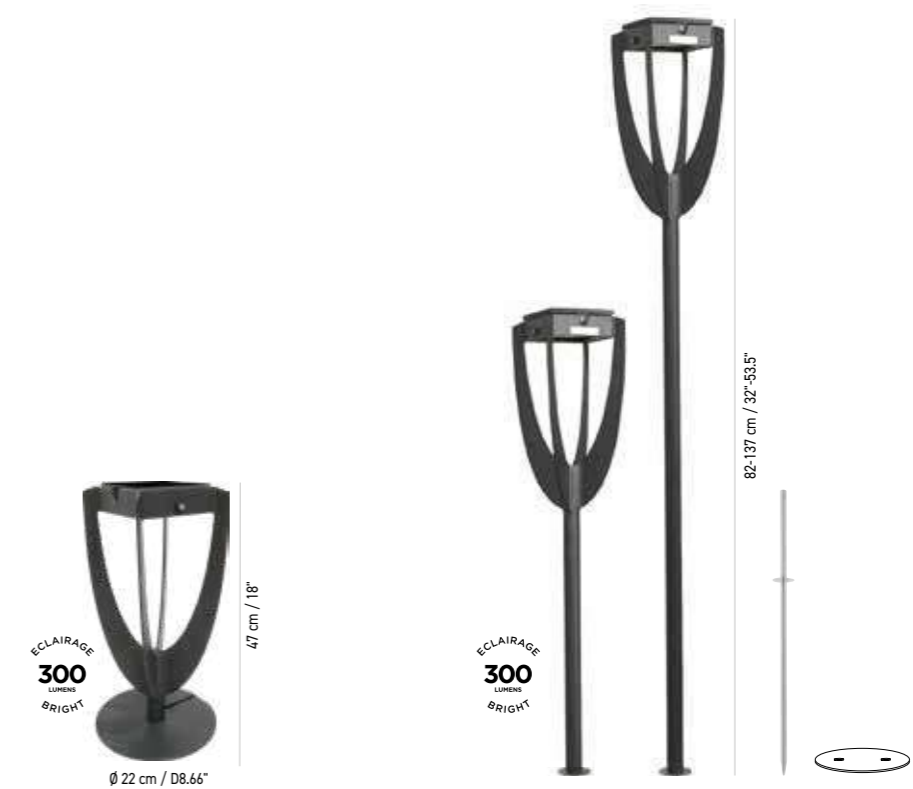

LAMPE TULIP
À POSER OU À FIXER
TULIP LAMP
PATHWAY OR TO FIX

 TINK303 265 €
Gris espace, Space grey

 TINK304* 265 €
Couleur Corten, Corten color

Aluminium
Aluminum

 1pc/1box  0,023 m³



 1,20 kg 



TORCHE TULIP À PLANTER OU À SCELLER
2 HAUTEURS AJUSTABLES
TULIP TORCH
TO PLANT OR TO FIX, TWO HIGH 32" AND 53,5"

 TINK300 319 €
Gris espace, Space grey

 TINK302 319 €
Couleur Corten, Corten color

Aluminium
Aluminum

 1pc/1box  0,043 m³

 2 kg 

IMPLANTATION LUX /DISTANCE
TEST RÉALISÉ AVEC UNE TORCHE TINK300 OPTION 500 LM

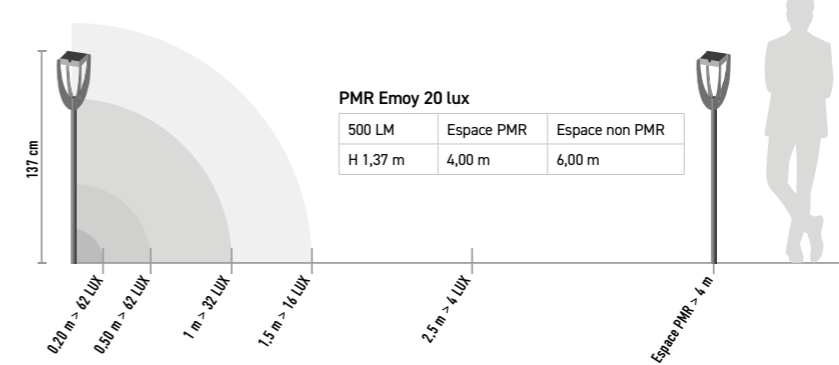

* Ces produits sont disponibles sur commande. These products are available to order.



METRO

Design by 2x5 design



NOUVEAU // BORNE ET APPLIQUE SOLAIRES ET RECHARGEABLES I-500LM MAX ☀️

NEWS // SOLAR AND RECHARGEABLE PATHWAY LIGHT AND WALL LIGHT I-500LM MAX ☀️



BORNE METRO À FIXER
METRO PATHWAY LIGHT TO FIX

TINK550 419 €
Gris espace, Space grey

TINK557 419 €
Couleur Corten, Corten color

Aluminium
Aluminum

1pc/1box 0,035 m³
2 kg

APPLIQUE MURALE METRO
METRO WALL LIGHT

TINK553 279 €
Gris espace, Space grey

TINK556 279 €
Couleur Corten, Corten color

Aluminium
Aluminum

1pc/1box 0,015 m³
1 kg

IMPLANTATION PMR
POUR UNE BORNE TINK550 500 LM

PMR Emoy 20 lux

500 LM	Espace PMR	Espace non PMR
H 0,90 m	3,00 m	4,50 m

METRO

NOUVEAU // LAMPADAIRES SOLAIRES ET RECHARGEABLES I-500LM MAX ☀️

NEWS // SOLAR AND RECHARGEABLE LAMPPOSTS I-500LM MAX ☀️



LAMPADAIRE METRO À FIXER
METRO DOUBLE HEAD LAMPPOST
TO FIX

- TINK552 959 €
Gris espace, Space grey
- TINK555 959 €
Couleur Corten, Corten color

Aluminium
Aluminum

1pc/1box 0,228 m³
6,3 kg

LAMPADAIRE METRO À FIXER
METRO SIMPLE HEAD LAMPPOST
TO FIX

- TINK551 579 €
Gris espace, Space grey
- TINK554 579 €
Couleur Corten, Corten color

Aluminium
Aluminum

1pc/1box 0,093 m³
5 kg

IMPLANTATION LUX /DISTANCE
TEST RÉALISÉ AVEC UN LAMPADAIRE TINK551 500 LM

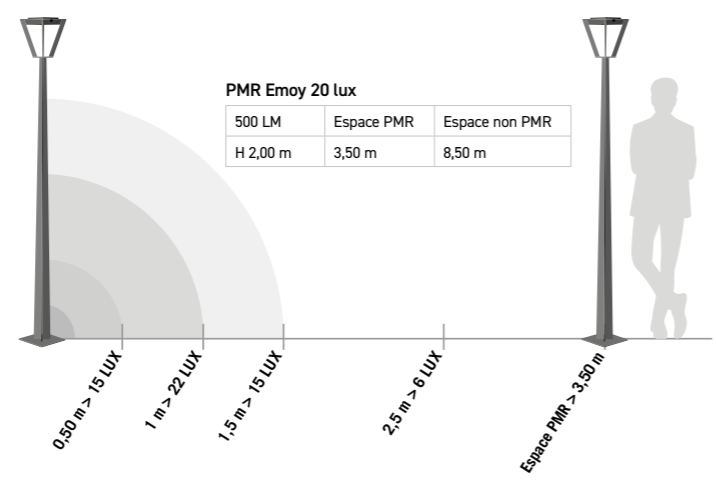

IMPLANTATION LUX /DISTANCE
TEST RÉALISÉ AVEC UN LAMPADAIRE TINK555 500 LM

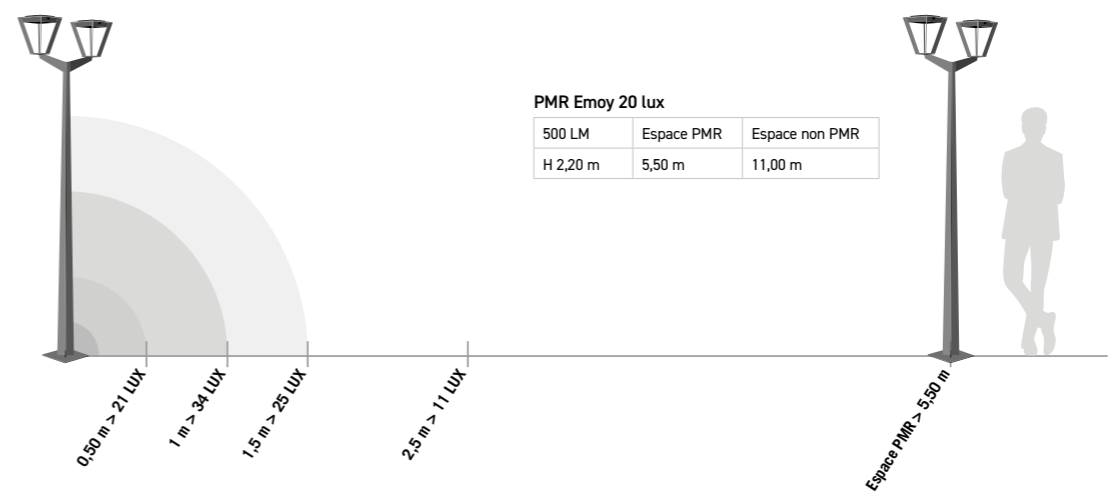

OJE

Puissant, intelligent et grande autonomie
Powerful, intelligent and high battery life

SPOT SOLAIRE

SOLAR SPOTLIGHT

OJE SPOT SOLAIRE
OJE SOLAR SPOTLIGHT

SPOT001B 169 €

ABS manganese,
Manganese ABS

6 pcs/1box 0,0046 m³
600 g

OPTION POSSIBLE :
BASE PIERRE EN GRANIT
POUR SPOT SOLAIRE
AVAILABLE OPTION:
STONE BASE
FOR SPOTLIGHT

BSP0001 29 €

Pierre, Stone

1pc/1box 1,206 g
0,008 m³



ECLAIRAGE
600
LUMENS
BRIGHT

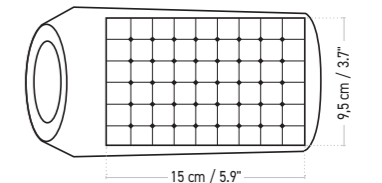
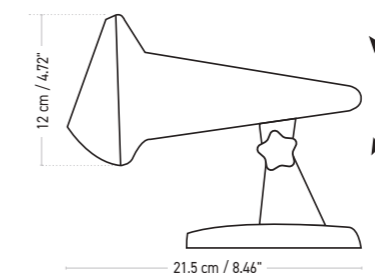
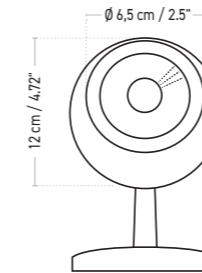

OPTIQUE TECHNOLOGIE LED

Led haute puissance : 600 LUMENS
Température de couleur : 2700 K
(blanc chaud)
Distribution lumineuse : en faisceau Optique 24°

LED TECHNOLOGY OPTICS
High power LED : 600 LUMENS
Color temperature : 2700K (warm white)
Light distribution: 24° optical beam

BOITIER ET SUPPORT

En ABS, résistant aux chocs, léger et rigide.
Traité anti-UV.
Axe de rotation cranté.
Deux batteries lithium-ion 2,6 Ah remplaçable,
durée de vie de 4 à 10 ans.

SPOTLIGHT HOUSING AND STAND
Made of ABS, shock resistant, light and rigid.
Anti-UV treated
Notched rotation axis
Two 2.6 Ah lithium batteries replaceable,
lifetime of 4 to 10 years.

PANNEAU SOLAIRE

SunPower : 10 cellules
2,4 watts
Revêtement ETFE

SOLAR PANEL
SunPower : 10 cells
2,4 watts
ETFE coating

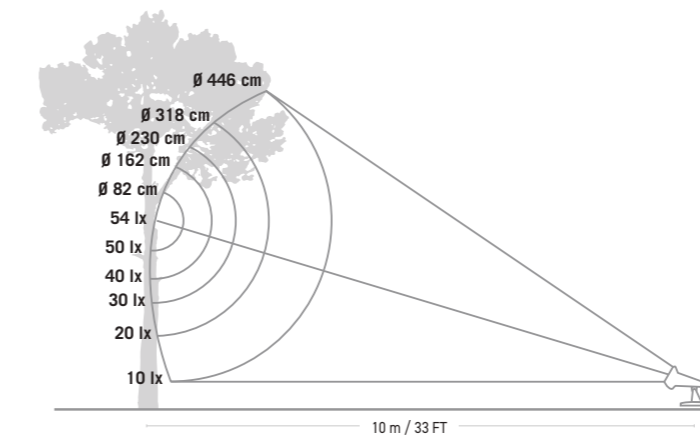

LUX /DISTANCE pour une implantation à 10 m
LUX /DISTANCE form a position 33 FT away

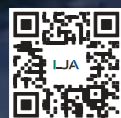
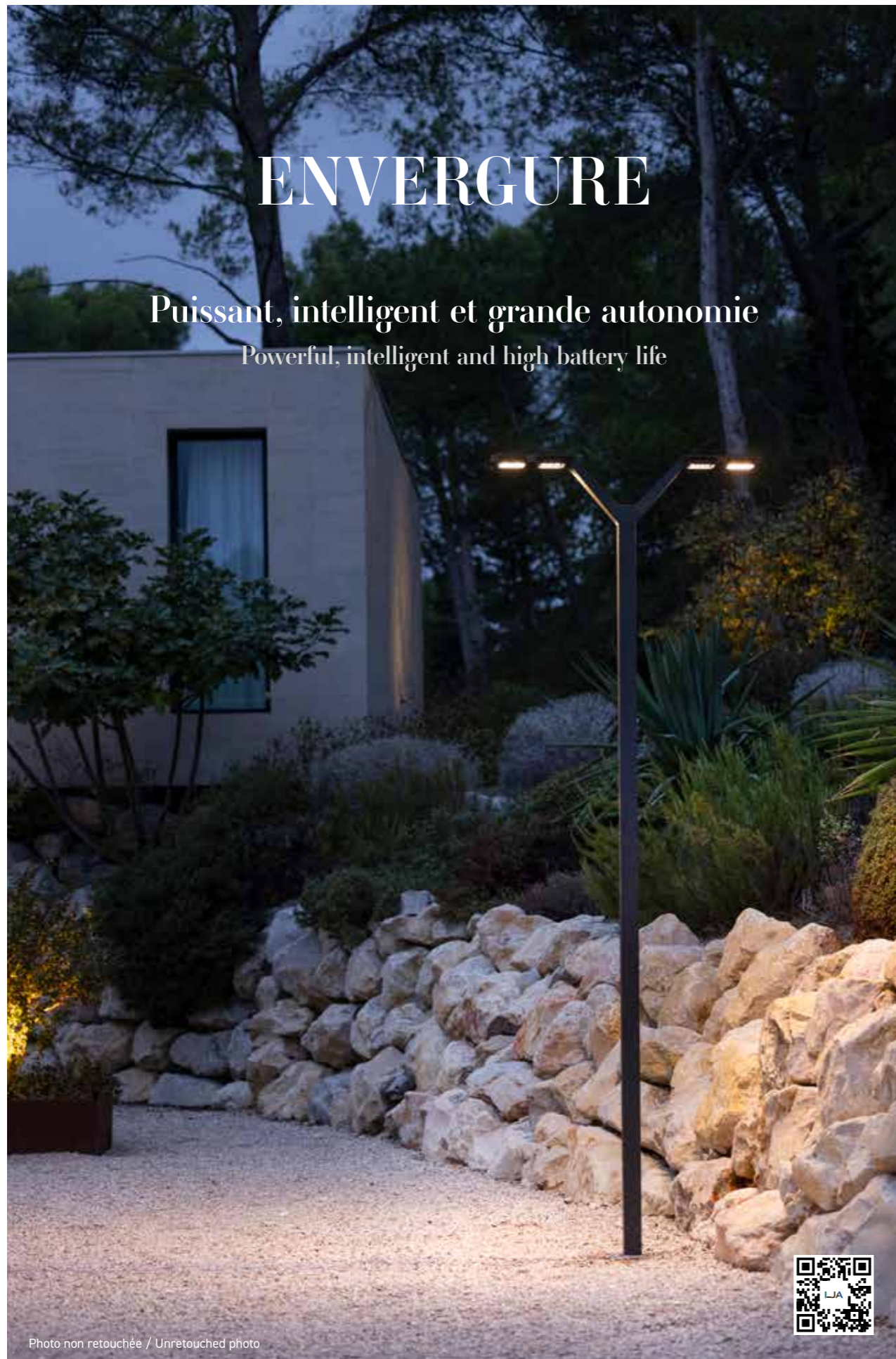

Photo non retouchée / Unretouched photo



ENVERGURE

Puissant, intelligent et grande autonomie
Powerful, intelligent and high battery life





Photo non retouchée / Unretouched photo

NOUVEAU // LAMPADAIRES SOLAIRES ET RECHARGEABLES I-500LM MAX ☀️





NEWS // SOLAR AND RECHARGEABLE LAMPPOSTS I-500LM MAX ☀️

LAMPADAIRE SOLAIRE
 SOLAR LAMPPOST

 **TINK560 1569 €**
 Gris espace, Space grey

 **TINK561* 1569 €**
 Couleur Corten, Corten color

Aluminium, verre dépoli acrylique
 Aluminum, acrylic frosted glass

 1pc/1box  0,205 m³
 10 kg 

-  **MODE INTELLIGENT**
SMART MODE
-  **AUTONOMIE**
DE 5 A
200h
UP TO LIGHTING
-  **RECHARGEABLE**
USB-C
REFILLABLE
-  **CREPUSCULAIRE**
CREPUSCULAR
-  **INTENSITE REGLABLE**
DIMMABLE
-  **DÉTECTEUR**
MOTION SENSOR
-  **TOUS TEMPS**
WEATHERPROOF
IP66

* Ce produit est disponible sur commande.
 This product is available to order.



IMPLANTATION LUX / DISTANCE TEST RÉALISÉ AVEC
 UN LAMPADAIRE TINK560 1000 LM

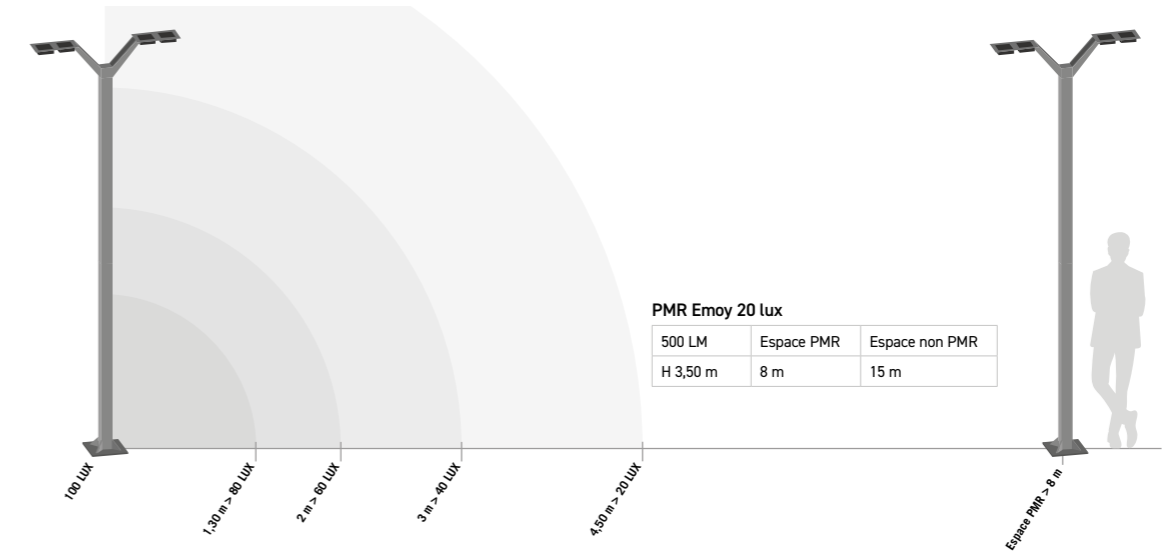

SOLAIRE

LES BONNES PRATIQUES D'UNE INSTALLATION RÉUSSIE

Pour profiter pleinement de votre lampe solaire, suivez ces bonnes pratiques d'installation :

- 1. Emplacement du module :** Assurez-vous que le soleil éclaire directement le module pendant au moins 3 heures par jour, et ce, tout au long de la saison d'exploitation.
- 2. Réglages du module :**
 - > Mode 1 : Intelligent. Votre lampe s'ajustera automatiquement selon les conditions d'éclairage.
 - > Détecteur de mouvement : Veillez à ce qu'il soit activé. Il est pré-activé lors du premier démarrage.
 - > Bouton de verrouillage : Assurez-vous qu'il soit bien verrouillé. Consultez le manuel ou notre tutoriel pour plus de détails sur cette manipulation.
- 3. Orientation du détecteur de mouvement :**
 - > Positionnez la lentille blanche située sur le côté du module 500 lumens vers la zone de passage pour une détection optimale.

En suivant ces étapes simples, vous garantirez une performance optimale et une longue durée de vie à votre lampe solaire. Profitez de votre éclairage écologique !

BEST PRACTICES FOR A SUCCESSFUL INSTALLATION

To get the most out of your solar lamp, follow these installation best practices:

- 1. Module Placement:** Ensure the module is directly illuminated by the sun for at least 3 hours a day throughout the operating season.
- 2. Module Settings:**
 - > Mode 1: Smart. Your lamp will automatically adjust according to the lighting conditions.
 - > Motion Detector: Make sure it is activated. It comes pre-activated upon the first startup.
 - > Lock Button: Ensure it is securely locked. Refer to the manual or our tutorial for details on how to do this.
- 3. Motion Detector Orientation:**
 - > Position the white lens on the side of the 500 lumen module towards the foot path for optimal detection.

By following these simple steps, you'll ensure optimal performance and longevity for your solar lamp. Enjoy your eco-friendly lighting!

NORME PMR (personne à mobilité réduite)

Le niveau d'éclairage moyen horizontal au sol est de 20 lux (Emoy = 20 lux). Ce tableau vous permet de consulter nos recommandations produits pour répondre à la norme PMR. Nous pouvons vous accompagner en fonction de vos besoins.

PMR STANDARD (persons with reduced mobility)

The average horizontal ground illuminance level is 20 lux (Emoy = 20 lux). This table provides our product recommendations to meet the PMR standard. We can assist you based on your needs.

Réf.	Hauteur (cm)	Espacement PMR (m)	Espacement non PMR (m)
Ref.	Height (inches)	PMR Space (feet)	No PMR Space (feet)
TINK560 p/123	350 / 137.7"	8 / 26.2 Ft	15 / 26.24 Ft
TECKA83 p/29	90 / 35.4"	2,5 / 8.2 Ft	3 / 9.8 Ft
TD07K10 p/95	93 / 36.6"	3,25 / 10.6 Ft	5 / 16.4 Ft
TINK171 p/113	90 / 35.4"	3 / 9.8 Ft	4,5 / 14.7 Ft
TINKA53 p/111	90 / 35.4"	3 / 9.8 Ft	4,5 / 14.7 Ft
TINK550 p/117	90 / 35.43"	3 / 26 3 / 9.8 Ft	4,5 / 14.7 Ft
TINK300 p/115	137 / 53.9"	4 / 13.1 Ft	6 / 19.6 Ft
TINK552 p/119	220 / 86.6"	5,5 / 18 Ft	11 / 36 Ft
TINK551 p/118	200 / 78.7"	3,5 / 11.4 Ft	8,5 / 27.8 Ft

MATÉRIAUX / MATERIALS

TOILE / SLING



Ateja blanc
White Ateja

CORDE / ROPE



Corde ronde
beige chiné
Beige mottled
round rope

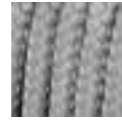

Corde ronde
grise
Grey round
rope

BOIS & VERRE / WOOD & GLASS



Teck massif
Solid teak



Teck massif
à la finition
Duratek®
Duratek® finish
solid teak.



Teck massif noir®
Black solid teak.



Verre dépoli
acrylique
Acrylic frosted
glass



Granit
Granit

PEINTURE / PAINT



Aluminium
couleur Corten
Corten color
aluminum



Aluminium
blanc
White
aluminum



Aluminium
Muscade
Muscade
aluminum



Aluminium
gris espace
Space grey
aluminum



Aluminium
noir
Black
aluminum

HPL / HPL



HPL béton ciré
White wash
Concrete HPL



HPL ardoise
Slate grey HPL



HPL céramique
lin
Lin ceramic
HPL

PETG / PETG

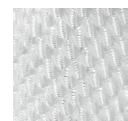

PETG
transparent
Clear PETG

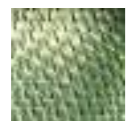

PETG olive
Green PETG

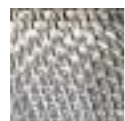

PETG cendre
Cender PETG



PETG safran
transparent
PETG



PETG ambre
transparent
PETG



PETG
transparent
Clear PETG



PETG ambre
Amber PETG



PETG turquoise
Turquoise PETG



PETG
transparent
Clear recycled
PETG



PETG noir
pailleté
Glittery black
PETG

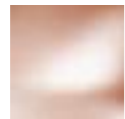

PETG
transparent
Clear recycled
PETG

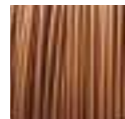

PETG Corten
Corten color
PETG

MATIÈRES / MATERIAL DESCRIPTION

Aluminium

Tube aluminium extrudé, peinture poudre polyester cuite au four. Pas d'entretien particulier.

Extruded aluminum tube, painting with powder coating. No maintenance required

Acier inoxydable

Pièces visseries, barres de tension de toiles Sling ou batyline en acier inoxydable. Demande un entretien régulier dès l'apparition de tâches d'oxydation, de préférence avec notre produit STARBRITE Ref NET08NP

STAINLESS STEEL

Spare parts (screw, tension bars for Sling or Batyline fabrics) in stainless steel. Regular maintenance when appearance of oxidation tasks. We rather recommend our STARBRITE ref. NET08NP Chrome and stainless polish

HPL : Stratifié haute pression

Se compose d'une feuille décor imprimée ou teintée dans la masse, imprégnée de résine mélamine, et d'une couche de support par empilage de papier krafts imprégnés de résine phénolique. Facile d'entretien, résiste aux rayures. Tous les matériaux s'altèrent aux UV, le HPL n'échappe pas à cette règle. Notre conseil : si vous avez acheté une table extensible avec un revêtement en HPL, et que cette dernière reste exposée toute l'année aux UV, laissez la table grande ouverte pour éviter une différence de couleur entre la rallonge et les plateaux.

High Pressure decorative Laminates (HPL), consisting of a surface of decorative paper(s) impregnated with aminoplastic resins and a core made of layers of kraft paper impregnated with phenolic thermosetting resins. All the layers are bonded together with simultaneous application of heat and high specific pressure to obtain a homogeneous non-porous material with increased density. Easy maintenance and cleaning, no special maintenance required. Scratch resistant. Our advise : if you buy an extending table with a HPL top and if the table stay all year long exposed at the UV's, keep the table open to avoid discoloration between extension and tops.

PETG

Le PETG (Polyéthylène Téréphtalate Glycol) est un matériau innovant et polyvalent utilisé dans l'impression 3D de nos lampes. Apprécié pour sa robustesse, sa résistance aux chocs et sa grande durabilité, il est idéal pour des créations alliant esthétique et performance. Grâce à sa transparence naturelle et sa capacité à diffuser la lumière de manière homogène, le PETG permet de concevoir des abat-jour élégants et résistants, parfaitement adaptés à un usage en intérieur comme en extérieur. Sa résistance aux UV lui permet de conserver son aspect et ses propriétés mécaniques plus longtemps, même en exposition prolongée au soleil. De plus, ce matériau est recyclable et moins sensible à l'humidité que d'autres plastiques, garantissant ainsi une excellente tenue dans le temps.

PETG (Polyethylene Terephthalate Glycol) is an innovative and versatile material used in the 3D printing of our lamps. Appreciated for its strength, impact resistance and durability, it is ideal for creations that combine aesthetics and performance. Thanks to its natural transparency and ability to diffuse light evenly, PETG can be used to design elegant, resistant lampshades, perfectly suited to both indoor and outdoor use. Its UV resistance means it retains its appearance and mechanical properties for longer, even when exposed to prolonged sunlight. What's more, this material is recyclable and less sensitive to humidity than other plastics, guaranteeing excellent durability over time.

Verre dépoli

Verre synthétique en acrylique, plus léger et moins fragile que le verre minéral. Il est dépoli pour une diffusion plus homogène de la lumière.

Entretien : nettoyage à l'eau

Frosted glass : Synthetic acrylic glass, lighter and less fragile than mineral glass. It's frosted for a better diffusion of light.

Maintenance : clean with water

Teck massif de plantation

Notre teck massif est issu de culture raisonnée.

Essence : Tectona Grandis



Our solid teak comes from reasoned culture.

Plantation teak. Species : Tectona Grandis

Duratek®

Protection longue durée de votre teck en extérieur ! Finies les contraintes d'un entretien fastidieux !

Le teck est préalablement soumis à un décapage mécanique qui lui donne un aspect vieilli et veiné. Puis, afin de le protéger durablement contre les UV, les intempéries et les taches domestiques (gras, café, vins, etc...), il subit un traitement exclusif, par application de 6 couches successives, lui conférant ce fini grisé très contemporain. Entretien : Ne pas huiler. Nettoyage à l'eau savonneuse

DURATEK® : The ultimate protection for your outdoor teak furniture. Say goodbye to teak maintenance once and for all!

Our teak is first vigorously brushed to obtain a textured and seasoned finish. Then, after a first coat of waterproofing primer, five coats of grey finish are applied. This process protects the wood against the weather, UVs and various stains such as wine, coffee or oil. The grey color we have chosen emphasizes our contemporary chic collections. Maintenance : Do not oil. Clean with soapy water

* Teck massif à la finition Duratek®. Duratek® finish solid teak.

ENTRETIEN / CLEANING PRODUCTS

TECK

NETTOYANT
DÉGRISSEUR
POUR TECK
SPRAY 1 L
NETDFP6



Colisage : 6pcs/1box
Poids : 0,8 kg
46 €

PROTECTEUR
POUR TECK
0,950L
PROTDF3



Colisage : 12pcs/1box
Poids : 1,1 kg
68 €

INOX

POLISH POUR
CHROME
ET INOX
0,237 L
NET08NP



Colisage : 6pcs/1box
Poids : 0,4 kg
32 €

HPL kit

NETTOYANT HPL
DEGRAISSANT
HYPERACTIF
750 ML
NETHPL1
15,90 €



+

RAVIVEUR
PROTECTEUR
HPL
250 ML
RAVHPL2
42,90 €



General terms of sale between professionals

1 - General

These conditions are valid vis-à-vis those purchasers from Industry, Trade and various other lines of business.

Any order implies total acceptance of these general terms of business (GTB) from the purchaser without reserve.

They will prevail all contrary provisions that could appear on the order forms, general terms of purchase or any other document from the purchaser. Any derogation from these GTB must be expressly accepted by SEL.

2 - Orders

Any order placed must be confirmed in return by SEL – LES JARDINS to engage our commitment.

Any order placed directly through one of our representatives involves our commitment only if it is confirmed by our sales department.

Any modification, or cancellation, even partially, must be agreed previously by our company.

Any additional order following an order confirmation will be considered as a new order.

3 - Prices

Prices are quoted EXW our warehouse (59553). Any sale is based on prices and general terms confirmed in our order confirmation. Prices and technical description describe in our general catalogue are only for information.

We may revise our prices at any time in function of economic changes.

The valid prices are the one shown on the order confirmation at the date of order. Our prices are available upon request.

4 - Stock

Our products are sold according to the stock available.

Our company reserves the right to cancel a model from the collection at any time and without notice.

5 - Delivery time

The delivery time mentioned in our commercial documents is for information only and in good faith. Therefore, if any delay occurs, the purchaser has no right to refuse the goods in case of fortuitous events or should unforeseen circumstances happen.

6 - Transport

Our goods are sold ex-warehouse. Even in the case of carriage-paid invoicing, goods travel at the consignee’s risk. From a total order of €1,000 excluding VAT per delivery, shipment is made carriage paid to Metropolitan France. (Exclusively reserved for CHR retailers and professionals). For all orders under €1,000 excl. tax, a flat-rate charge of €50 excl. tax will be invoiced. For islands: Corsica, îles de Ré, Ile d’Oléron, Belle-Ile-En-Mer, etc... transport will be invoiced in addition. For export orders, goods will be sold EXW from our warehouse in DOUAI (59500) or FOB from our factories.

6 -1 - Accessibility of delivery site - bulk :

Additional charges will be applied depending on the accessibility of the delivery site and the size or weight of the goods. Our delivery rates are based on normal access conditions for national transport (minimum 19 T truck).

The customer must ensure in advance that the goods are accessible and that delivery can be made under these conditions. Should this not be the case, the purchaser will bear all related costs, including those associated with a second delivery with adapted vehicle, personnel and equipment, and will in no way constitute grounds for order cancellation.

Any absence on the day of delivery without prior notification by e-mail to our services 48 hours in advance will be subject to invoicing for an additional delivery.

Invoicing for the first delivery will remain the responsibility of the purchaser.

7 - Reception - Claims - Returns

The consignee shall check the number of packages at the state of the goods in the presence of the delivery man.

Any claim shall be mentioned on the transport receipt and confirmed to the forwarder by recorded delivery letter with acknowledgement receipt within two open days. A copy must be sent to us within the same time.

Without any claim within this delay, goods will not be replaced or refunded.

No credit note or product replacement will be accepted in case of claim declared more than 2 weeks after the delivery date.

No product return will be accepted without our agreement. Return will be only accepted if goods in their original packing, at consignee’s charge, and mentioning our bill of return number confirmed by our sales department.

Product return in carriage forward will be refused.

8 - Terms of Payment:

The total amount of the invoice needs to be paid at the deadline shown on the invoice. Any derogation must get SEL written acceptance.

For advance payment, within 10 days following delivery, we offer a 1 % discount, applicable only to professionals.

Any late payment shall bear interest in accordance with Article L441-6 of the French Commercial Code at 3 times the average rate applied by the European Central Bank to its most recent refinancing operation plus 10% plus a flat-rate indemnity for collection costs of €40 excluding VAT (Article D441-5 of the French Commercial Code).

9 - Reserve of ownership

The goods are property of SEL up to the fulfillment of all commitments of the contractual relation. In spite of this clause, the responsibility of the goods is transferred to the purchaser as soon as the goods are given to the forwarder. The client has to take good care of the goods which are under retention of property, to inform the supplier immediately in writing about each change of location and interventions of a third party. If the goods are supplied to a third party according to the intended purpose, the client has to obligate this third party to observe the retention of property in accordance with the provisions mentioned above. In this case of disregard of the aforementioned determined liabilities of the client, SEL has the right to withdraw from the Further legal procedures might follow.

10 - Guarantee

The modules are guaranteed for two years against all manufacturing defects (in Europe only). The manufacturing code printed on the casing must be preserved to benefit from the warranty. The warranty excludes any misuse and deterioration. Warranty exclusions: if a fall caused visible damage, a crack, or a deep scratch, or invisible damage (electronic damage) impairing the normal functioning of the solar module. If the solar module has been submerged. If the solar module was purchased more than two years ago. If battery polarity has not been respected. In case of using batteries from another brand.

The lamp body (excluding the module) is guaranteed for two years against any manufacturing defects, independently of the legal warranty against hidden defects provided by Article 1641 of the Civil Code, and provided that proper care is taken during storage, assembly, and under normal use and maintenance conditions.

Please note that no complete product exchange will be made if the damaged part can be replaced. Replacement will be carried out by the reseller or the end customer. Only the manufacturing defect warranty applies to our products from the date of purchase by the end customer.

The following are expressly excluded from this warranty:

Changes in the appearance of teak due to aging, as teak is a living material and surface cracks may appear.

Corrosion of stainless steel parts (tension cable, sunbed support, screws, tension bars, etc.) in coastal or chlorinated and confined environments. Stainless steel requires regular maintenance; as soon as oxidation spots appear, they should be cleaned.

11 - Spare parts

All our spare parts are on stock for a 2 years period after product stop.

12 - Place of performance and jurisdiction

All the disputes and eventual claims to interpretation, execution or carrying out of an order can only be brought to the court of the city where our head office is located.

13 - Eco-Mobilier

Eco-Mobilier is a nonprofit organization accredited by the French government. The funds collected are fully allocated to financing the gathering and recycling of old furniture being trashed.

It includes furniture and furnishings such as seating, dining, bedding, shelving and counter tops.

From May 1st onwards, one shall label all furniture sold by any appropriate means with the following information: price, eco-mobilier additional fee, and total cost price + fee. This cost breakdown shall appear at the bottom of your receipt. This new tax will be charged to the end user.

Warning: The eco-fee being set by Eco-Mobilier, SEL-LES JARDINS

shall charge it to its clients and it can be changed without prior notice.

Les Jardins° is registered in the National Register of Marketers under number FR 019011. This number guarantees that Les Jardins°, by joining Ecomobilier, is in compliance with the regulatory obligations incumbent upon it in application of article L541-10-6 of the Environmental Code.

Conditions générales de vente entre professionnels

Article 1 - Champ d’application des conditions générales de ventes

Les présentes conditions s’appliquent aux ventes, aux acheteurs ayant une activité professionnelle.

Toutes commandes impliquent l’adhésion entière et sans réserve à nos conditions qui prévalent sur toutes stipulations pouvant figurer sur tout document émanant de l’acheteur.

Toute dérogation doit être acceptée par SEL.

Article 2 - Commande

Toute commande doit pour engager notre société, faire l’objet d’une confirmation de commande écrite de notre part. L’acceptation par nos clients, de nos confirmations de commande, implique leur adhésion aux présentes conditions générales de vente. La commande passée par l’intermédiaire d’un de nos représentants ne nous engage que si elle a été confirmée par notre service commercial.

Une modification, une annulation même partielle ne peut intervenir sans notre accord. Tout complément de commande postérieur à une confirmation de commande, constitue une nouvelle commande.

Article 3 - Conditions de prix

Toutes les ventes sont conclues sur la base du prix et des conditions de prix mentionnés sur notre confirmation de commande. Nos prix et renseignements contenus dans notre catalogue sont fournis à titre indicatif. Seuls les prix et renseignements figurant sur nos bons de commande engage la responsabilité de notre société.

Article 4 - Stock

Nos produits sont vendus dans la limite des stocks disponibles. Nous nous réservons le droit à tout moment et sans préavis de supprimer un modèle de notre collection.

Article 5 - Délai

Les délais de livraison sont donnés à titre indicatif, les retards éventuels ne donnent pas droit à l’acquéreur d’annuler sa commande, de refuser la marchandise ou de réclamer des dommages intérêts.

La société est libérée de l’obligation de livraison pour tout cas fortuits et/ou de force majeure.

Article 6 - Transport

Nos marchandises sont vendues départ de nos entrepôts. Même en cas de facturation franco, les marchandises voyagent aux risques et périls du destinataire. A partir d’un total de commande de 1 000 € HT par livraison, l’expédition est faite franco de port France Métropolitaine. (Exclusivement réservé aux revendeurs et professionnels CHR). Pour toute commande inférieure à 1000 €/HT un montant forfaitaire de 50 €/HT sera facturé. Pour les îles : Corse, îles de Ré, Ile d’Oléron, Belle-Ile-En-Mer, etc... le transport sera facturé en sus. Pour toute commande export la marchandise sera vendue au départ (EXW) de notre entrepôt de DOUAI (59500) ou FOB depuis nos usines.

6-1 Accessibilité du lieu de livraison - encombrement :

Des frais supplémentaires seront appliqués en fonction de l’accessibilité du lieu de livraison de la marchandise, et de l’encombrement des marchandises ou de leur poids. Nos tarifs de livraison s’entendent pour des conditions normales d’accès par des transports nationaux (camion minimum 19 T).

En cas d’accès difficile nécessitant l’utilisation d’un véhicule de livraison de gabarit réduit (type petit camion), un supplément forfaitaire de 150 € HT sera appliqué aux frais de livraison. La qualification d’« accès difficile » est appréciée par le transporteur ou notre service logistique.

Le client doit s’assurer au préalable de l’accessibilité et de réalisation de la livraison dans ces conditions. Dans le cas contraire, l’acheteur supportera tous les frais afférents y compris ceux attachés avec une seconde livraison avec véhicule, personnel et matériel adapté et ne constituera en rien un motif d’annulation de commande. Toute absence le jour de la livraison sans information par mail auprès de nos services 48h00 au préalable fera l’objet d’une facturation d’une livraison supplémentaire. La facturation de la première livraison restera à l’entière charge de l’acheteur.

Article 7 - Réception - Réclamations - Retour marchandises

Il appartient au destinataire, en présence du livreur, de constater les retards, l’avarie des produits, leur nombre.

Toute réclamation devra être formulée sur le récépissé du transporteur et confirmée à ce dernier par lettre recommandée avec AR dans les 48h ouvrables suivant la réception. Une copie devra nous être transmise dans ce délai.

A défaut de réclamation dans ce délai, les marchandises ne seront ni échangées, ni remboursées.

Aucun avoir ou échange ne sera effectué en cas de litige déclaré plus de 15 jours après la date de réception effective des marchandises.

Aucun retour de marchandise ne peut être effectué sans notre accord préalable écrit. Un retour ne sera accepté que si les marchandises sont retournées aux frais du client, dans leur emballage d’origine, et avec mention du numéro de retour attribué par nos services.

Les produits retournés en port dû ou en contre remboursement seront refusés.

Article 8 - Conditions de règlement

Toutes nos marchandises sont payables comptant avant expédition ou en contre-remboursement à la livraison sauf accord écrit.

Pour tout paiement comptant sous 10 jours date de facture, un escompte de 1 % sera effectué, applicable uniquement aux professionnels.

Tout retard de paiement porte intérêt selon l’article L441-6 du Code de Commerce à 3 fois le taux moyen appliqué par la Banque Centrale Européenne à son opération de refinancement la plus récente majoré de 10% avec en sus une indemnité forfaitaire pour frais de recouvrement de 40 € HT (article D441-5 du Code de Commerce).

Article 9 - Réserve de propriété

Les marchandises vendues restent notre propriété jusqu’à la disponibilité pour nous de l’intégralité du montant facturé. Nonobstant cette clause, la charge des risques est transférée à l’acquéreur dès la remise des marchandises au transporteur. L’acheteur est autorisé à revendre les marchandises à condition d’avoir réglé intégralement le vendeur ou de communiquer au vendeur le jour même de la revente, copie du contrat de revente, identité de l’acquéreur, conditions de paiement. Jusqu’à complet paiement, l’acheteur prendra les dispositions nécessaires pour faire apparaître aux tiers la propriété de SEL. L’acheteur déclare en outre, irrévocablement céder au vendeur, à concurrence du montant de sa dette envers celui-ci, ses droits de créance sur son acquéreur, garantir au vendeur la solvabilité actuelle et future de cet acquéreur et s’engage à payer lui-même à défaut de celui-ci.

Si les marchandises sont destinées à des ventes successives, l’acheteur s’engage à porter et faire porter une clause identique à celle-ci en faveur de SEL dans les différents contrats, l’acheteur demeurant garant.

SEL pourra reprendre toutes marchandises impayées, cette reprise n’étant pas exclusive d’autres procédures.

Article 10 - Garantie

Les modules sont garantis deux ans contre tous vices de fabrication (en Europe seulement). Le code de fabrication imprimé sur le boîtier doit être préservé pour bénéficier de la garantie. La garantie exclue toutes mauvaises utilisations et détériorations. Exclusion de garantie : Si une chute a occasionné des dégâts visibles, une fissure ou une forte rayure, ou invisibles (dommages électroniques) altérant le fonctionnement habituel du module solaire. Si le module solaire a été immergé. Si le module solaire a été acheté il y a plus de deux ans. Si la polarité des batteries n’a pas été respectée.

En cas d’utilisation de batteries d’une autre marque.

Le corps de la lampe (hors module) est garanti durant deux années contre tout vice de fabrication indépendamment de l’application de la garantie légale contre les vices cachés prévue par l’article 1641 du Code Civil et dans la limite où des soins convenables devront être pris lors de leur stockage, montage et sous réserve d’une utilisation et d’un entretien normal.

Attention, aucun échange complet d’un produit ne sera effectué, si la pièce détériorée peut être remplacée. Le remplacement s’effectuera par le revendeur ou le client final. Seule la garantie vice de fabrication s’applique sur nos produits à compter de la date d’achat par le client final.

Sont expressément exclus de la présente garantie :

- Les évolutions d’aspect du teck liées à son vieillissement, le teck étant un matériau vivant, il peut apparaître des fissures à sa surface.

- La corrosion des pièces inox (câble de tension, béquille de bain de soleil, visserie, barres de tension, ...) en front de mer ou dans un environnement chloré et confiné. L’inox nécessite un entretien régulier, dès l’apparition de tâches d’oxydation, celle-ci doivent être nettoyées

Article 11 - Pièces détachées

Nos pièces détachées (d’usure ou de casse) sont gérées en stock jusqu’à 2 ans après la date d’arrêt du produit concerné.

Article 12 - Litiges

A défaut d’un accord amiable sur les éventuels différends, ceux-ci relèvent exclusivement de la compétence du tribunal de commerce de notre siège social.

Article 13 - Eco participation

Eco-mobilier est une société sans but lucratif, agréée par les pouvoirs publics. Les sommes perçues seront intégralement affectées au financement de la collecte et du recyclage des déchets d’ameublement ménagers.

Les produits concernés sont les meubles et éléments d’ameublement qui offrent une assise, un couchage, du rangement, un plan de pose ou de travail.

A partir du 1^{er} Mai 2013, vous devrez indiquer, par voie de marquage, d’étiquetage, d’affichage ou par tout autre procédé approprié, pour tous les meubles que vous vendez, dont les meubles de jardin, en plus du prix, le montant de l’éco-participation Mobilier et le total prix + éco-participation. Ce triple affichage devra aussi paraître au pied de la facture et du ticket de caisse. Cette nouvelle taxe devra donc être répercutée à l’identique auprès du consommateur final.

Attention : L’éco-participation étant fixée par Eco-Mobilier, SEL – LES JARDINS sera dans l’obligation de répercuter à sa clientèle, en totalité et sans aucun préavis, toute modification intervenant dans le montant de celle-ci.

Les Jardins° est enregistré au Registre national des metteurs sur le marché d’éléments d’ameublement sous le numéro FR 019011. Ce numéro garantit que Les Jardins°, en adhérant à Ecomobilier, est en conformité avec les obligations réglementaires qui lui incombent en application de l’article L541-10-6 du Code de l’Environnement.

Price list valid from 09.01.2025 to 08.31.2026

SEL - 1115 rue René Descartes - ZAC du Parc de la Duranne - 13100 Aix-en-Provence - France
Tél. (33) 04 42 90 45 30 - Fax (33) 04 42 90 70 11 - Email : contact@lesjardins.com - www.lesjardins.com

RC AIX 2002 B 1217 - Siret 354 044 257 00054 - APE 516 K - TVA FR 49354044257 - SAS au capital social de 451 290 Euros



FR

Donnez ou recyclez vos meubles.



Association

ou



Magasin

ou



Déchèterie

<https://quefairedemesdechets.fr>



LES JARDINS®
1115 rue René Descartes - ZAC du Parc de la Duranne
13100 Aix-en-Provence - France
Tél. (33) 04 42 90 45 30 - Fax (33) 04 42 90 70 11

SHOWROOM PROFESSIONNEL AIX-EN-PROVENCE